





DAL  
1981

## index

- |   |         |
|---|---------|
| . 1 SERIE 36G<br>pareti divisorie in vetro per ufficio<br><i>movable glass partitions for the office</i>  | pag. 6  |
| . 2 SERIE 110SC<br>pannelli divisori per ufficio con scuretto<br><i>office partitions with shadow gap</i> | pag. 32 |
| . 3 SERIE 470E<br>pareti divisorie attrezzate per ufficio<br><i>storage partition walls</i>               | pag. 54 |
| . 4 SERIE 80A - 100B<br>pareti divisorie economiche per ufficio<br><i>best price office partitions</i>    | pag. 72 |
| . 5 FINITURE<br><i>FINISHES</i>   | pag. 88 |



# Fipe System

Rendiamo concreto il desiderio del cliente che si affida a noi

La Fipe System nasce nel 1981. Aldo Rosani insieme con la moglie Agata dà vita ad un ambizioso progetto imprenditoriale che nasce con un obiettivo preciso: REALIZZARE UN PRODOTTO PERSONALIZZATO DI QUALITÀ che soddisfi le necessità di una clientela esigente, che non si accontenta del prodotto standard. Sempre in crescita, l'azienda, nel 2000 si trasferisce nell'attuale sede di Cogliate per dar spazio ad un team più ampio e specializzato.

A partire dal 2017 sono Daniela e Fabio, i figli del fondatore da sempre in azienda, a mettersi alla guida della Fipe System, portando avanti i valori che da sempre la fondano.

I nostri servizi

Produzione: Soddisfiamo il cliente con soluzioni customizzate e d'avanguardia, realizzando prodotti originali e innovativi. Forti nella ricerca di tecnologie e con il costante aggiornamento di materiali e prodotti rendiamo concreto il desiderio del cliente che si affida a noi.

Vendita e montaggio: ascolto del cliente e supporto nelle scelte, rilievo misure, preventivi gratuiti, progettazione e disegni tecnici, fornitura e installazione con personale qualificato, assistenza tecnica post vendita, progetti custom su richiesta, progetti "chiavi in mano" dell'ufficio (pavimenti, controsoffitti, ecc...).

## *Turning our customers' wishes into reality*

*Fipe System was established in 1981. Aldo Rosani, along with his wife Agata, gives birth to an ambitious business project born with a clear objective:*

*MAKE A TAILORED QUALITY PRODUCT to meet the needs of demanding customers, who are not satisfied with standard products. As a result of its constant growth, in 2000 the company moved to its present headquarters in Cogliate to accommodate a larger and more qualified team.*

*Today Fipe System is run by Daniela and Fabio, who stepped into their father's position in 2017 to lead the company in line with its core values.*

*Our services*

*Production: we cater for our customers' needs with customized and pioneering solutions, creating original and innovative products. With a strong focus on technology research, we are constantly upgrading our materials and products to turn our customers' wishes into reality.*

*Sales and installation: active customer-listening and decision-making support, on-site measurements, free estimates, planning and technical drawings, supply and installation by qualified personnel, customer service, customised projects, "turnkey" office projects ( floors, false ceilings, etc ...).*



# SERIE

36G  
110SC  
470E  
80A-100B

Pareti divisorie in vetro per ufficio: trasparenza, brillantezza e leggerezza sono le caratteristiche distintive della parete vetrata. Il vetro è utilizzato come elemento principale dell'intera struttura e la rende una soluzione ottimale per ambienti di lavoro moderni ed eleganti, personalizzabili in infiniti modi grazie all'ampia gamma di finiture e alla facile integrazione con la parete attrezzata e gli armadi serie 470E.

Punto di forza di questa parete è l'assenza di montanti intermedi tra i vetri: la parete sfrutta infatti la portanza del vetro e la modularità del sistema per creare superfici continue. La versatilità, le caratteristiche tecniche e il gradevole effetto estetico ne fanno la nostra punta di diamante.

*Moveable glass partitions for the office: transparency, brightness and lightness are the distinctive features of these glass walls. The glass is used as the main element of the whole structure and makes it an optimal solution for modern, elegant work environments, customizable in infinite ways thanks to a wide range of finishes and easy integration with the storage walls and cabinets of the 470E Series.*

*The absence of intermediate uprights between the panes is the strength point of this wall, through which it is possible to create continuous surfaces thanks to the glass load-bearing capacity and system modularity. Versatility, technical specifications and attractive appearance make it our flagship product.*











. dettagli tecnici / *technical specifications*

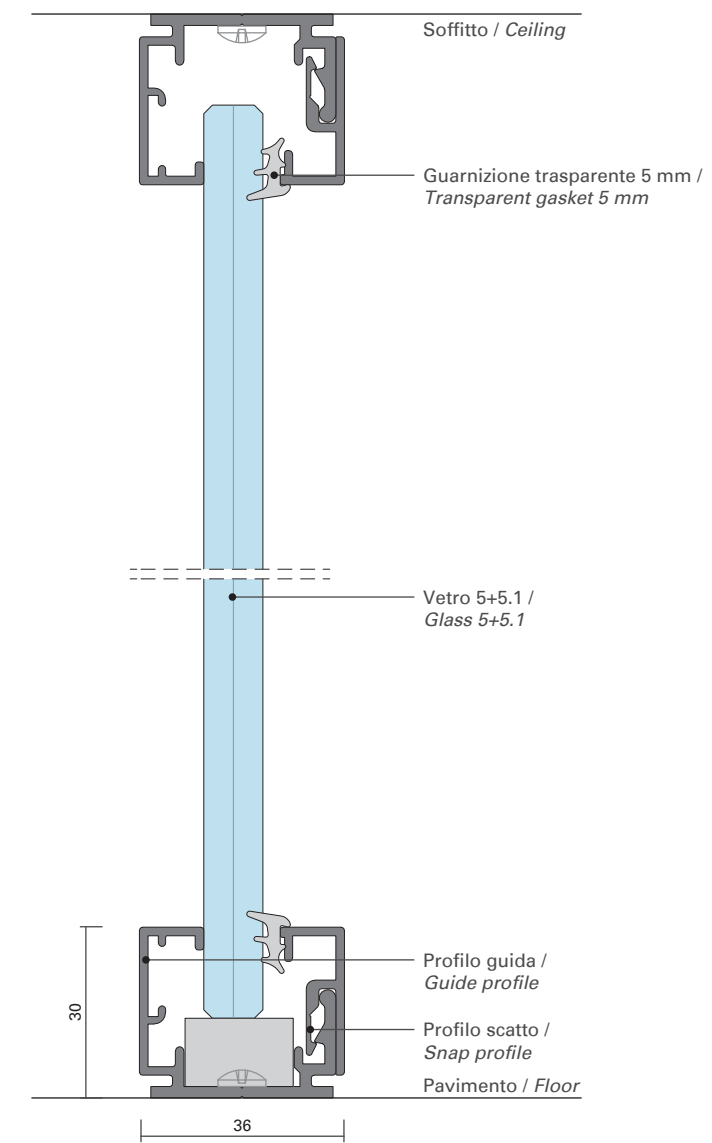

PROFILO H. 30 mm / *PROFILE H. 30 mm*

sezione verticale / *vertical section*

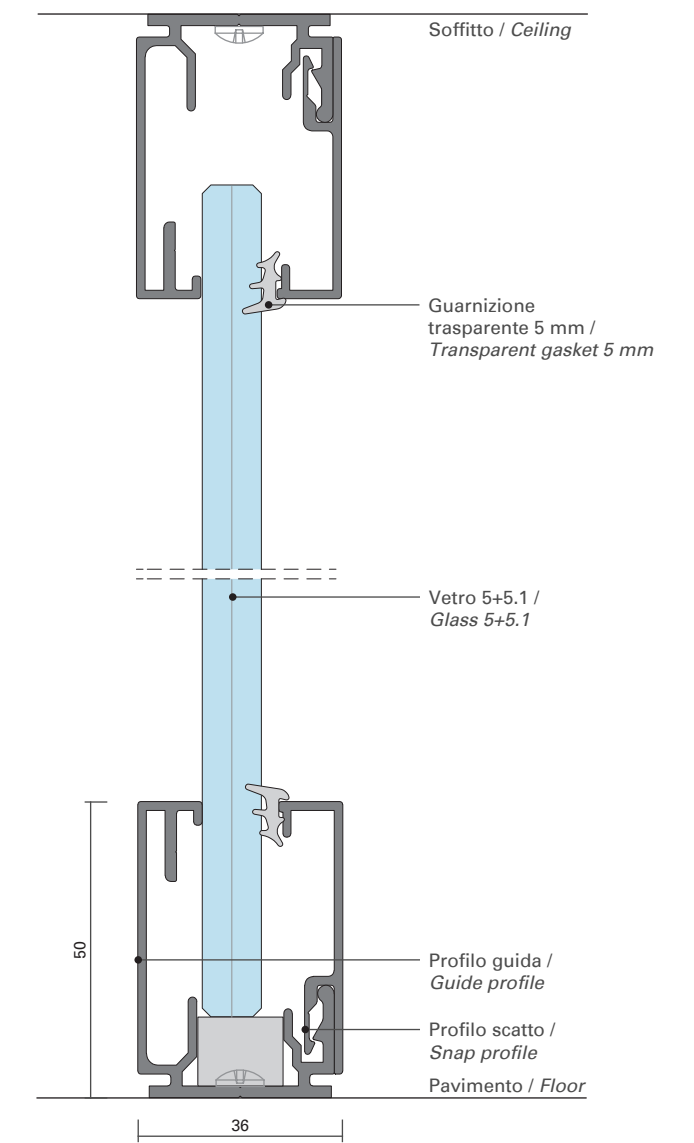

PROFILO H. 50 mm / *PROFILE H. 50 mm*

sezione verticale / *vertical section*





. moodboard



. 1 nobilitato / **melamine DR1 pecan naturale**

. 2 vetro trasparente / **clear glass**

. 3 alluminio grigio opaco / **matt grey coated aluminium**

. 4 pelle ocre / **ochre leather**

. 5 pelle grigio / **grey leather**

. 6 resina / **resin**







. dettagli tecnici / *technical specifications*

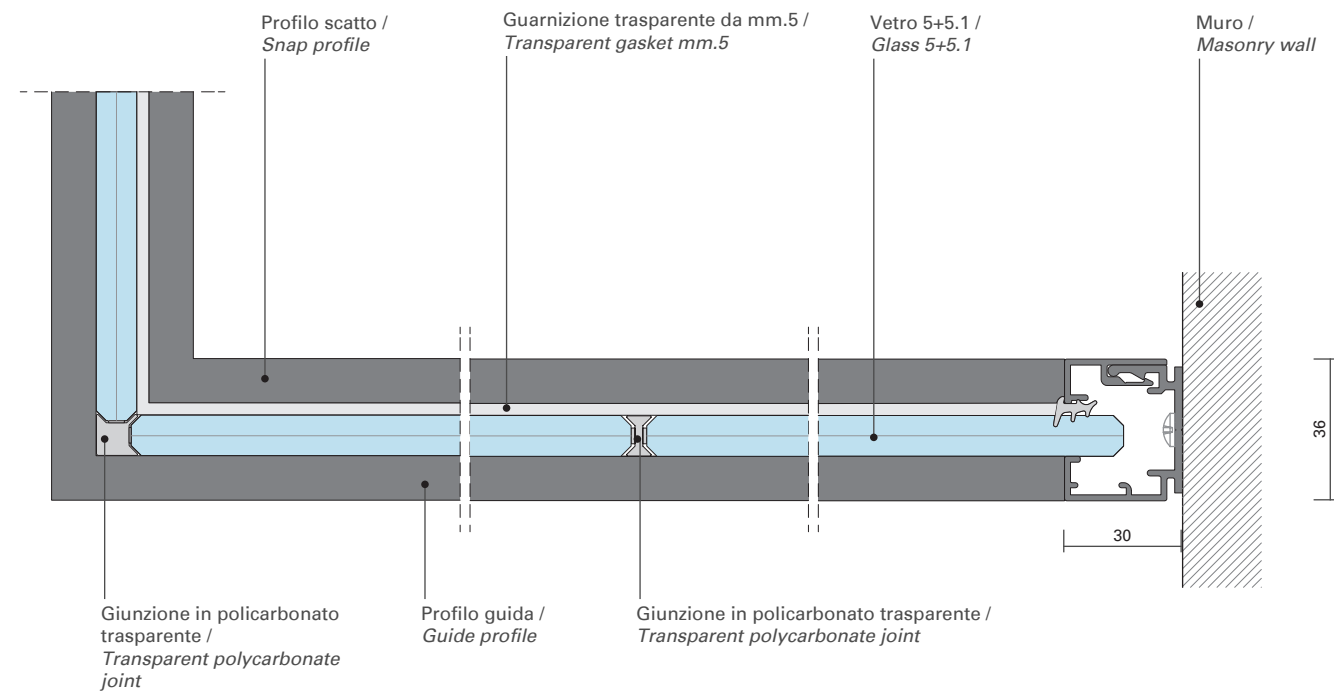

PARTENZA E GIUNZIONE 2 VIE /  
STARTING PROFILE AND 2-WAY JOINT

sezione orizzontale / *horizontal section*

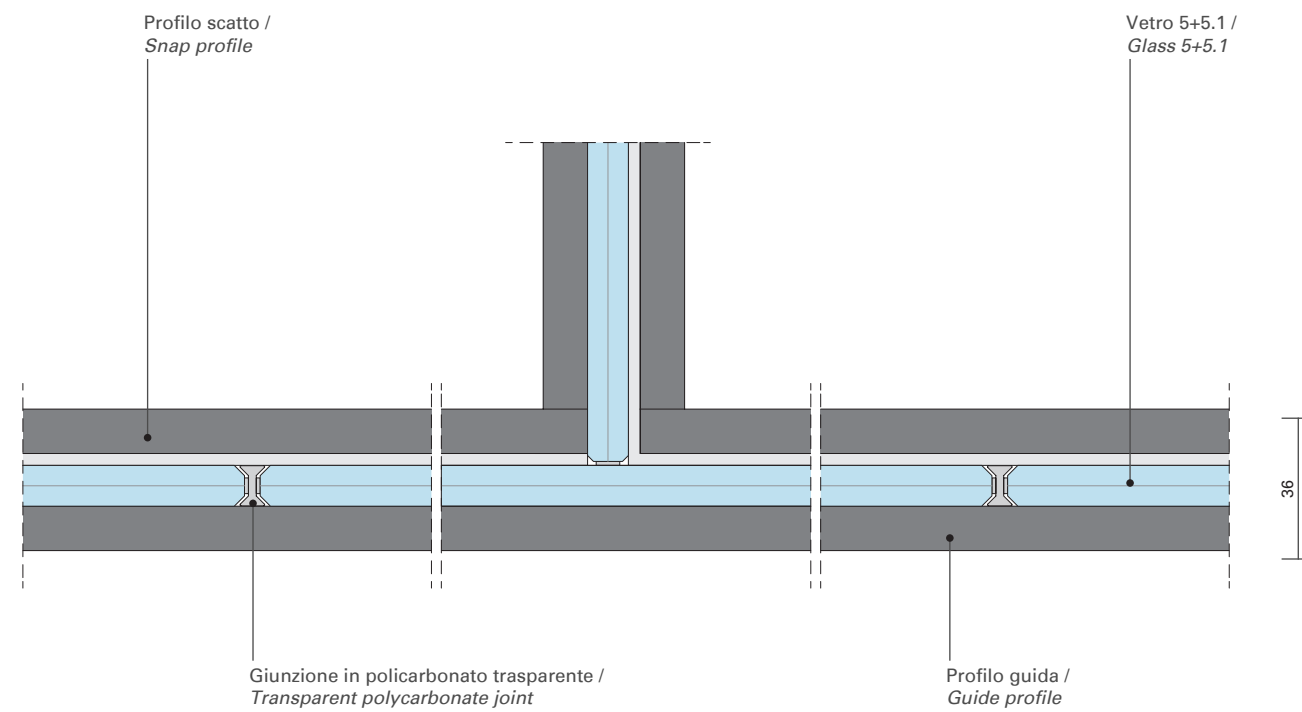

GIUNZIONE 3 VIE /  
3-WAY JOINT

sezione orizzontale / *horizontal section*







. dettagli tecnici / *technical specifications*

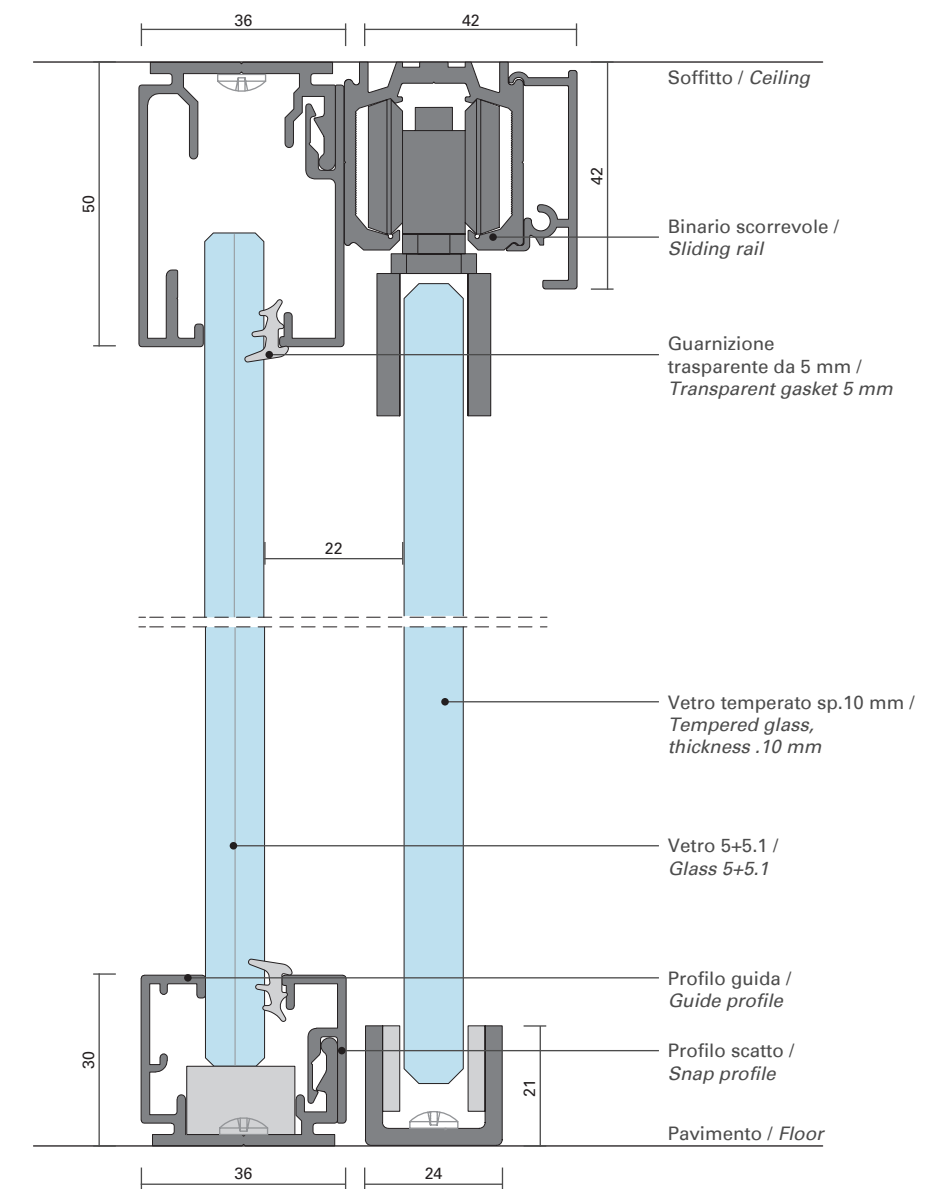

SEZIONE PORTA SCORREVOLE / *SLIDING DOOR SECTION*

sezione verticale / *vertical section*





. moodboard

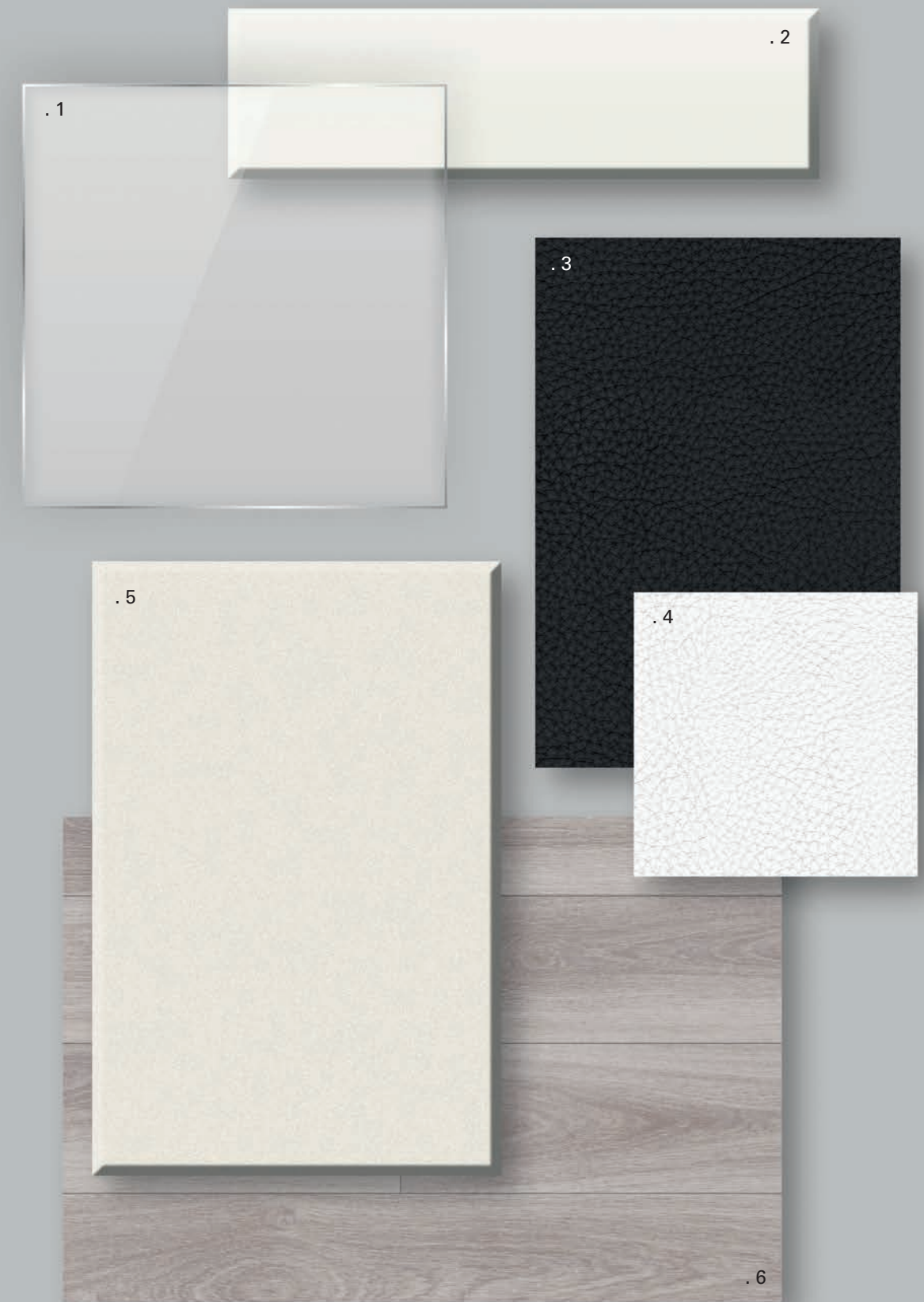

. 1 vetro trasparente / *clear glass*

. 2 alluminio bianco opaco / *matt white coated aluminium*

. 3 pelle nera / *black leather*

. 4 pelle bianca / *white leather*

. 5 nobilitato / *melamine OK8 unimetallic metal*

. 6 parquet / *parquet*









. dettagli tecnici / *technical specifications*

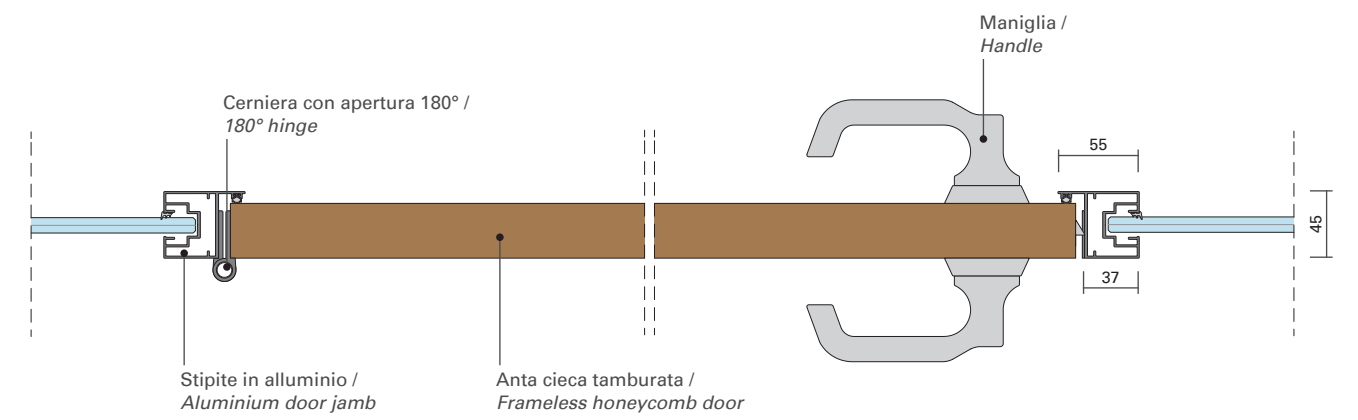

PORTA BATTENTE CIECA /  
FRAMELESS SWING DOOR

sezione orizzontale / *horizontal section*

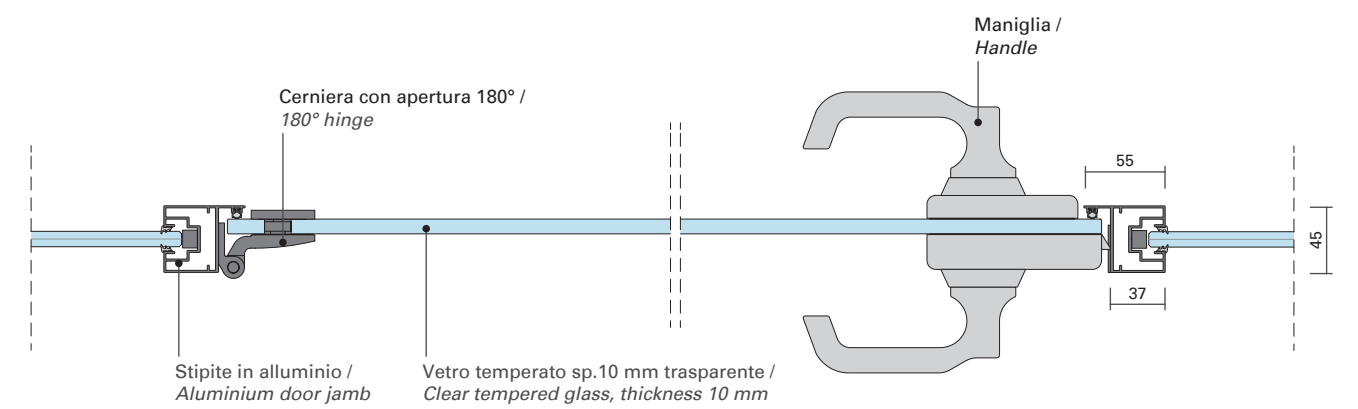

PORTA BATTENTE VETRATA FILO LUCIDO /  
SWING GLASS DOOR WITH POLISHED EDGE

sezione orizzontale / *horizontal section*

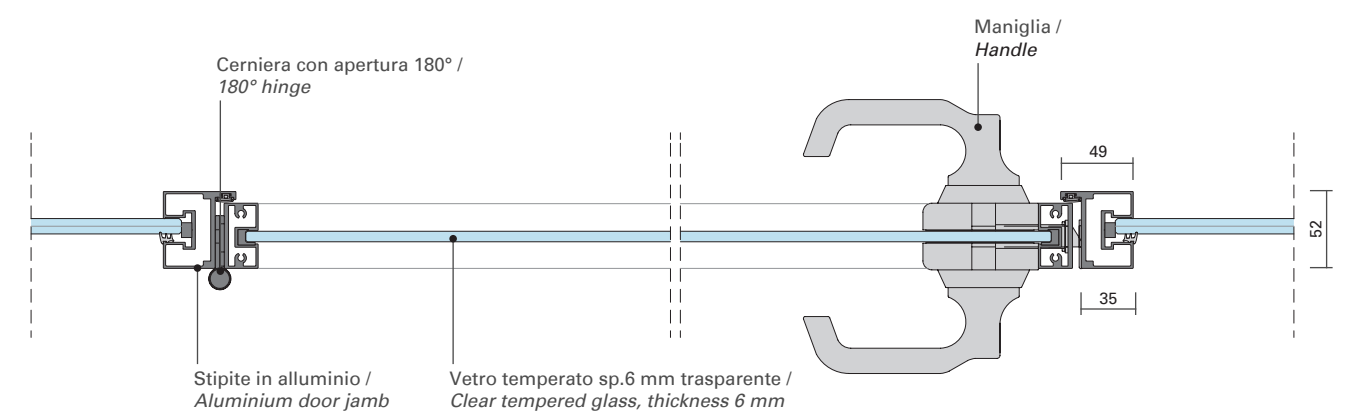

PORTA BATTENTE VETRATA INTELAIATA MINIMAL /  
MINIMAL FRAMED SWING GLAZED DOOR

sezione orizzontale / *horizontal section*





. moodboard



. 1 vetro fumè / *smoked glass*

. 2 alluminio nero opaco / *matt black coated aluminium*

. 3 nobilitato / *melamine D72 eureka chiaro*

. 4 tessuto verde bosco / *forest green fabric*

. 5 pelle foresta / *forest leather*

. 6 parquet

. abaco moduli 36G / *abaco 36G modules*

Versione completamente vetrata / *Fully glazed partition*

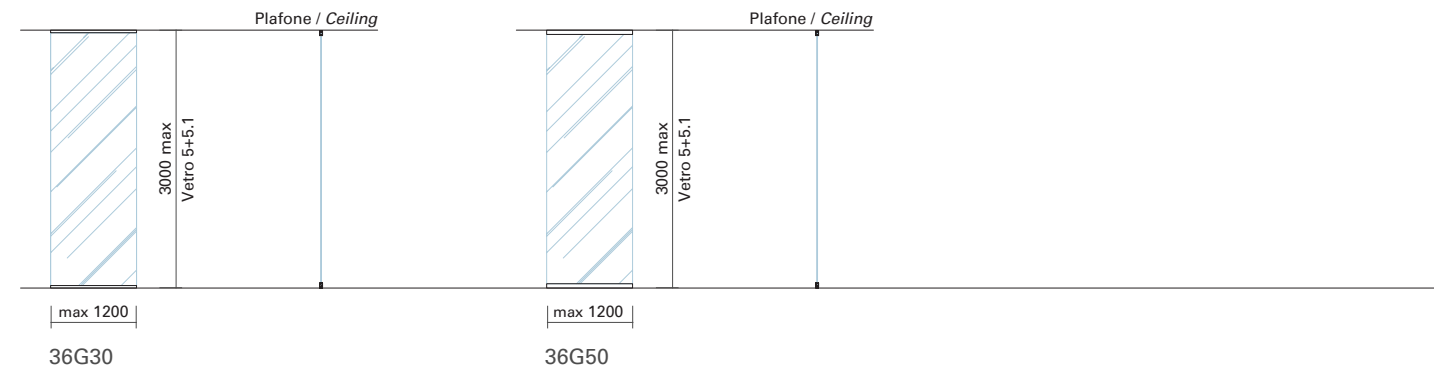

Versione completamente vetrata / *Fully glazed partition*

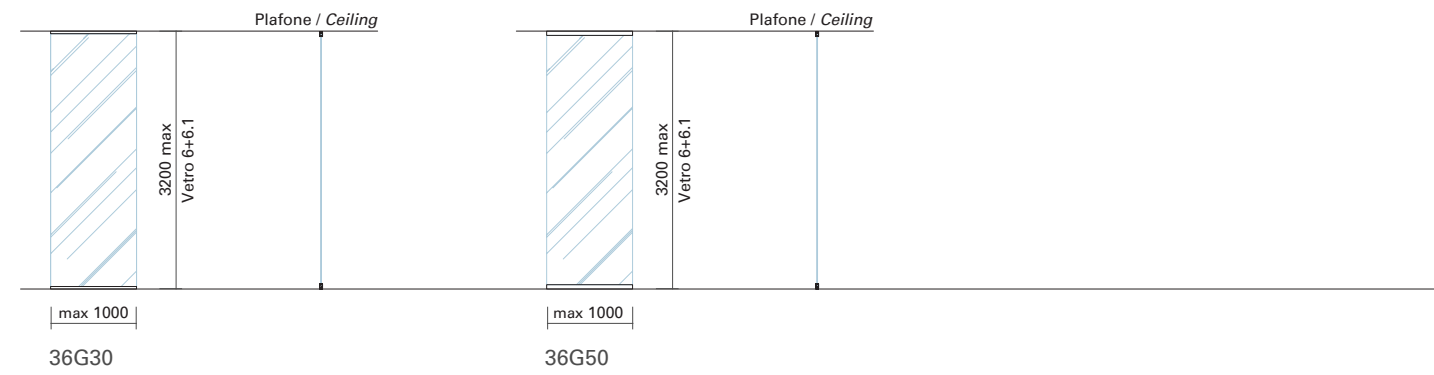

Versione autoportante / *Support-free partition*

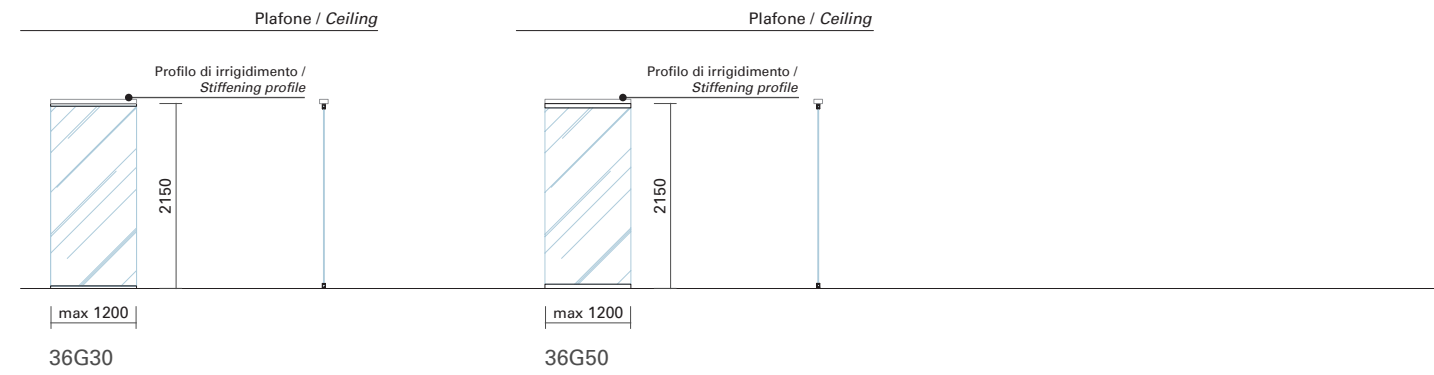

. abaco porte / *abaco doors*

Porte vetrate filo lucido a tutta altezza / *Full height glazed door with polished edge*

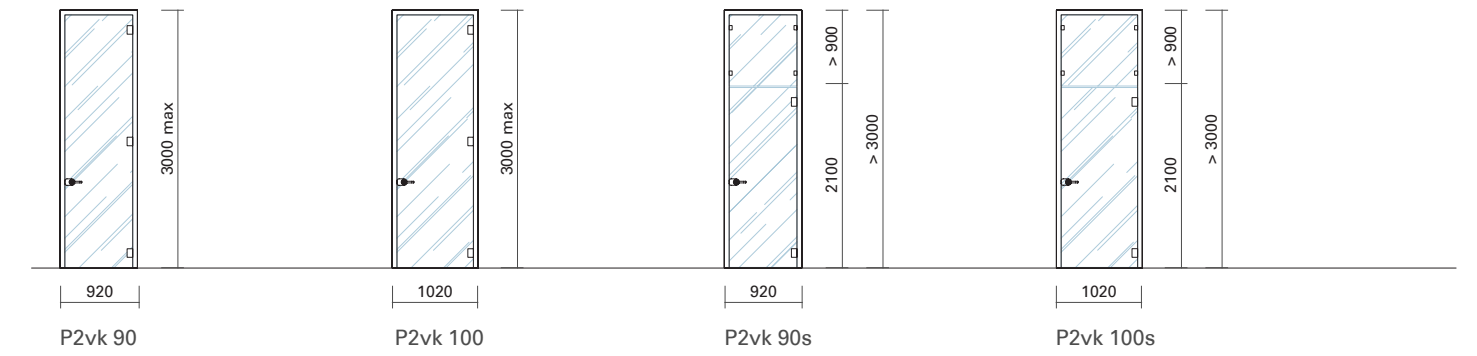

Porte cieche tamburate / *Frameless honeycomb doors*

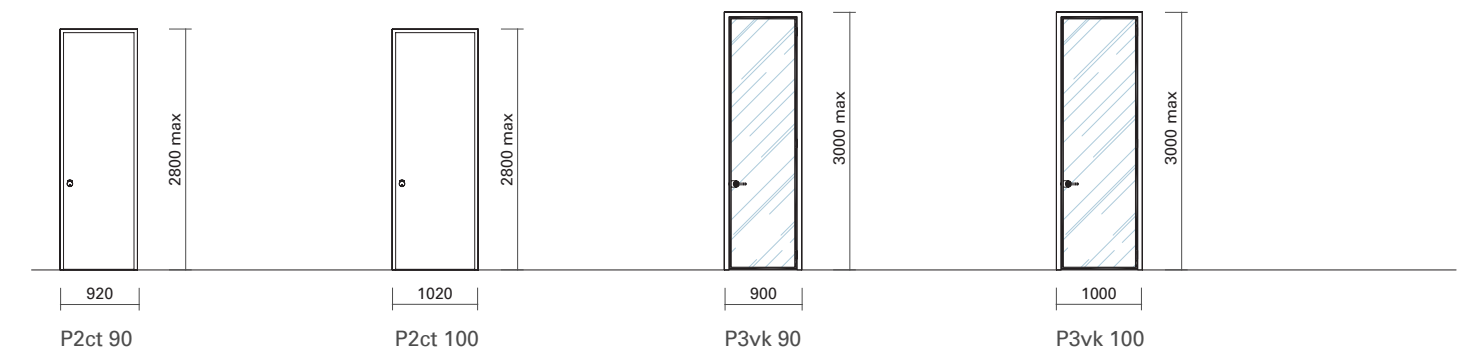

Moduli porte vetrate intelaiate minimal / *Minimal frameless glazed door modules*

Porte scorrevoli / *Sliding doors*

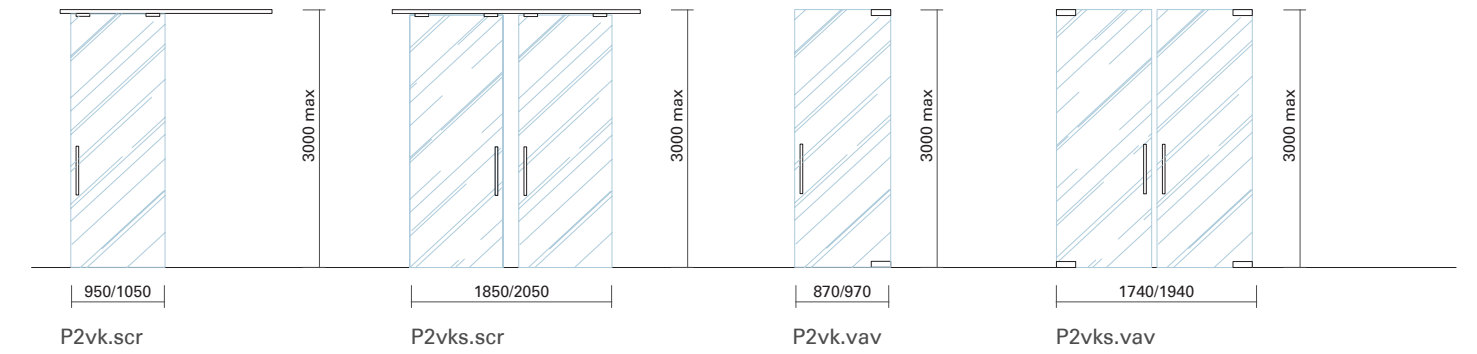

Moduli porte va vieni / *Double-acting door modules*

# SERIE

36G  
110SC  
470E  
80A-100B

Pannelli divisori per ufficio con scuretto: la parete con scuretto è caratterizzata da fughe orizzontali e verticali che le conferiscono grande dinamismo e un aspetto estetico moderno ed elegante.

Si adatta perfettamente alla suddivisione di ambienti quali: uffici direzionali, sale congressi, sale riunioni e reception.

La parete divisoria dispone di un'ampia gamma di finiture, sia per le pareti cieche sia per quelle vetrate, e può essere facilmente integrata con il sistema di pareti attrezzate e armadi della serie 470E.

*Office partitions with shadow gap: the walls with shadow gap feature horizontal and vertical joints that create a highly dynamic, modern and elegant appearance. They are perfect as room dividers for offices, conference rooms, meeting rooms and reception areas.*

*Both frameless and glazed partitions come in a wide range of finishes and offer easy integration with the storage walls and cabinet system of the 470E Series.*









. dettagli tecnici / *technical specifications*

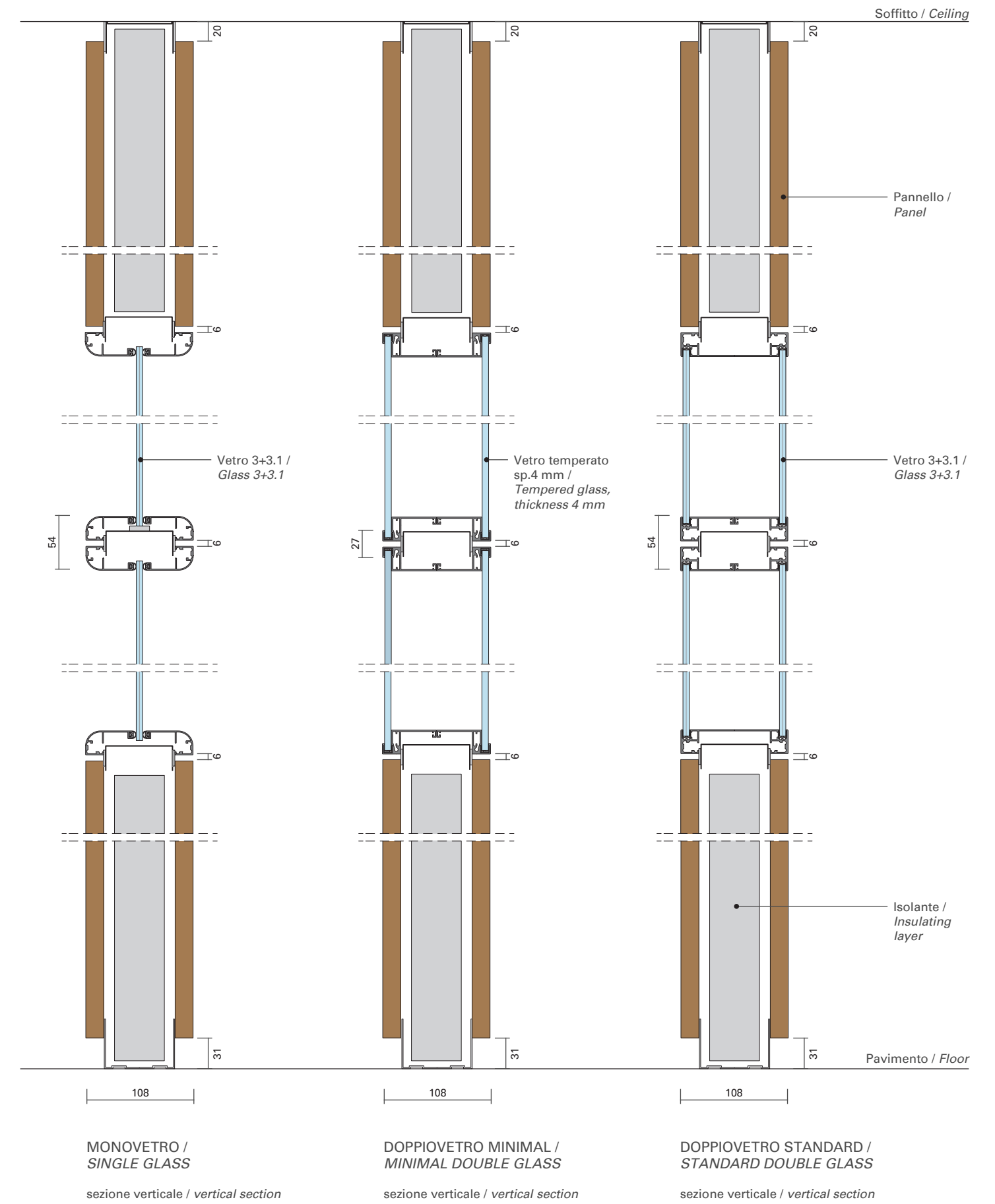





. moodboard



. 1 vetro trasparente / *clear glass*

. 2 alluminio nero opaco / *matt black coated aluminium*

. 3 nobilitato / *melamine 797 grigio grafite*

. 4 tessuto bianco / *white fabric*

. 5 resina / *resin*







. dettagli tecnici / *technical specifications*

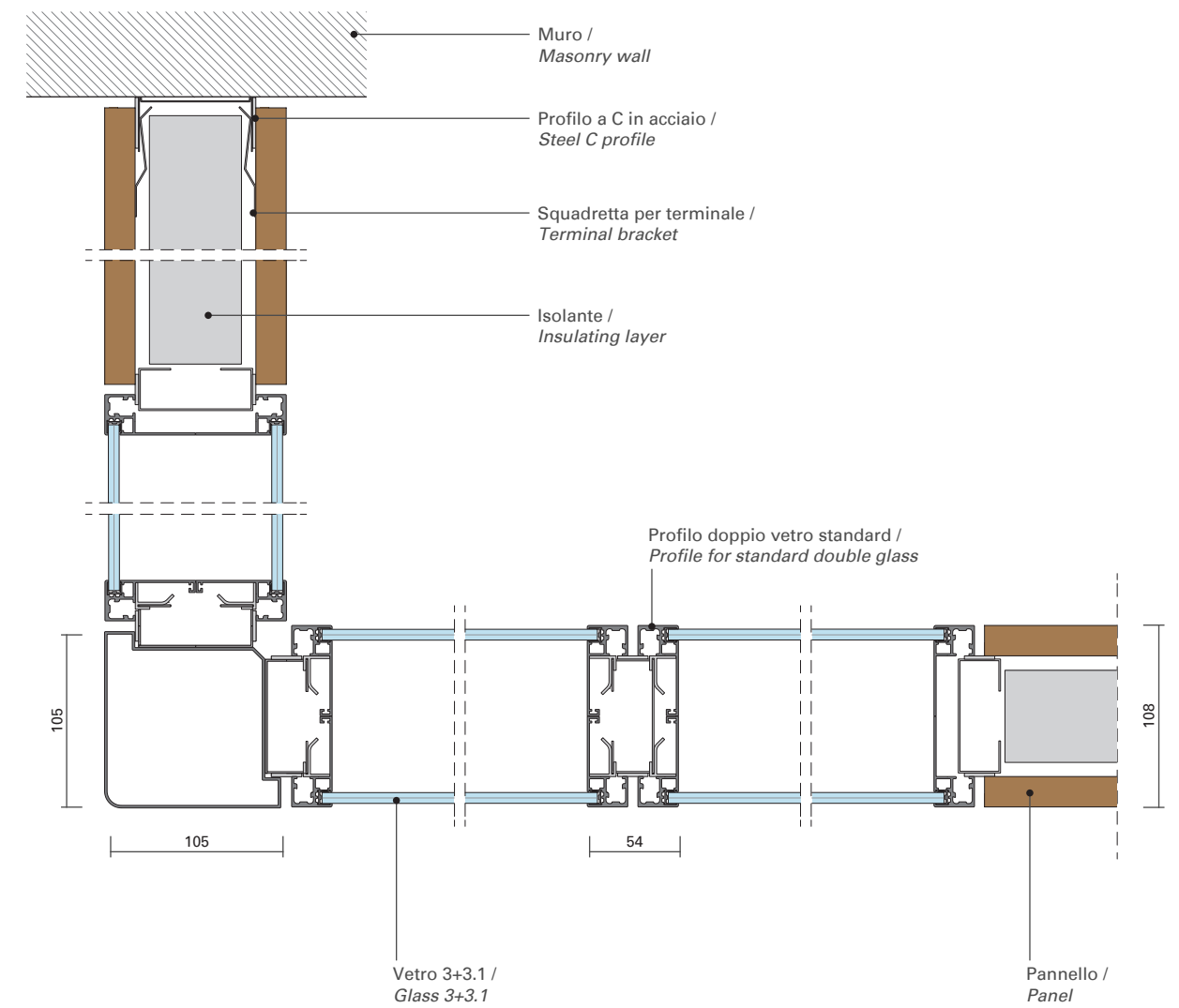

ANGOLO 2 VIE 90° /  
2-WAY 90° CORNER PIECE

sezione orizzontale / *horizontal section*

. dettagli tecnici / *technical specifications*

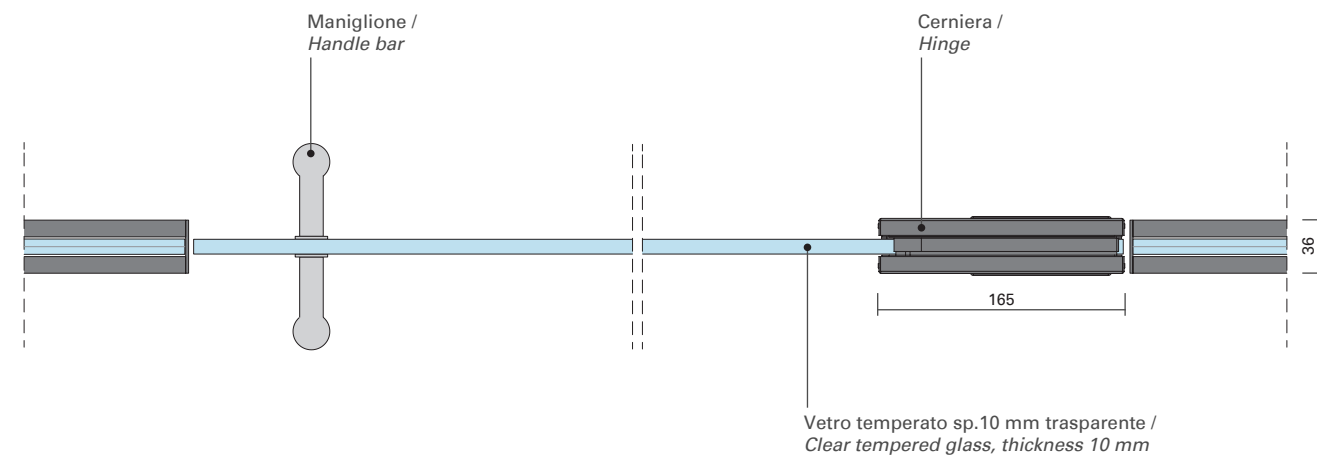

SEZIONE PORTA SINGOLA VA VIENI SU PARETE VETRATA /  
DOUBLE-ACTING DOOR SECTION ON GLAZED PARTITION

sezione orizzontale / horizontal section

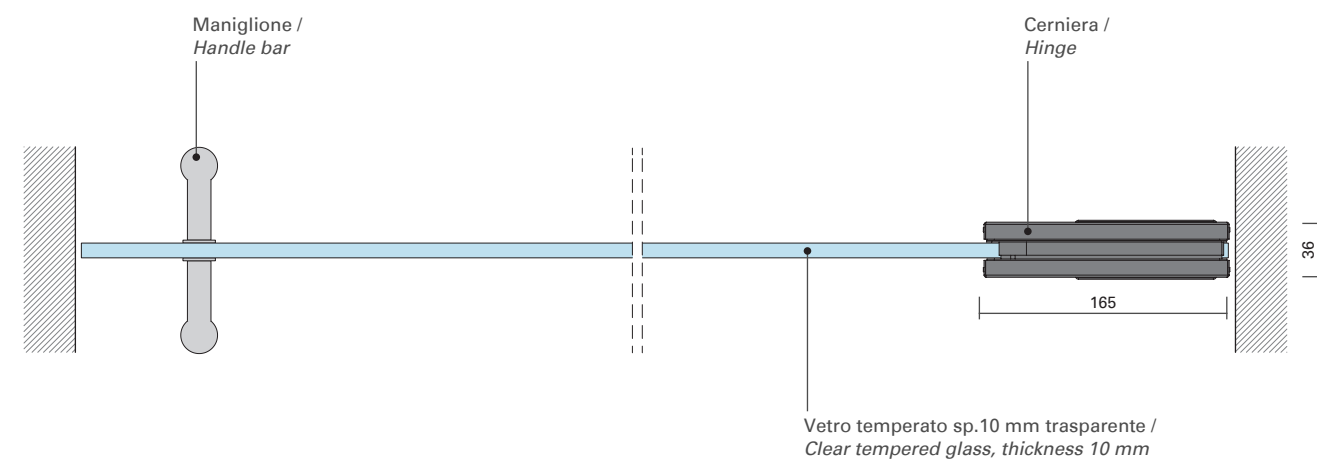

SEZIONE PORTA SINGOLA VA VIENI SU MURATURA /  
DOUBLE-ACTING DOOR SECTION ON MASONRY WALL

sezione orizzontale / horizontal section



Porta doppia va vieni su muratura / Two-panel double acting door on masonry wall





. moodboard



. 1 vetro trasparente / *clear glass*

. 2 alluminio ossidato naturale / *natural anodized aluminium*

. 3 nobilitato / *melamine TR9 oxyd*

. 4 pelle nera / *black leather*

. 5 pelle muschio / *musk leather*

. 6 cemento / *concrete*









Serie 110SC

. moodboard

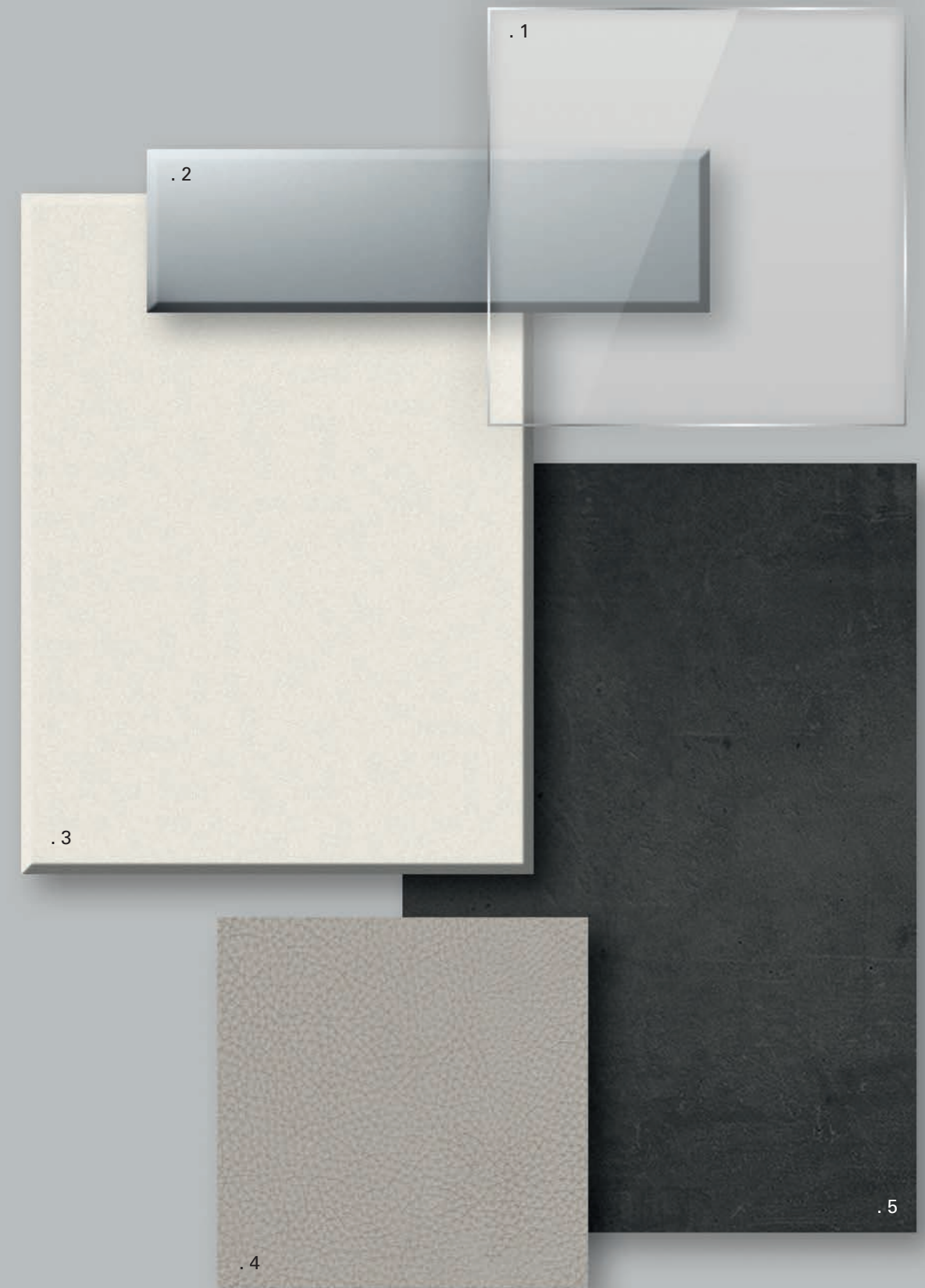

. 1 vetro trasparente / *clear glass*

. 2 alluminio ossidato naturale / *natural anodized aluminium*

. 3 nobilitato / *melamine OK8 unimetallic metal*

. 4 pelle tortora / *dove-grey leather*

. 5 resina / *resin*

## . abaco moduli 110SC / abaco 110SC module

Moduli standard / Standard modules

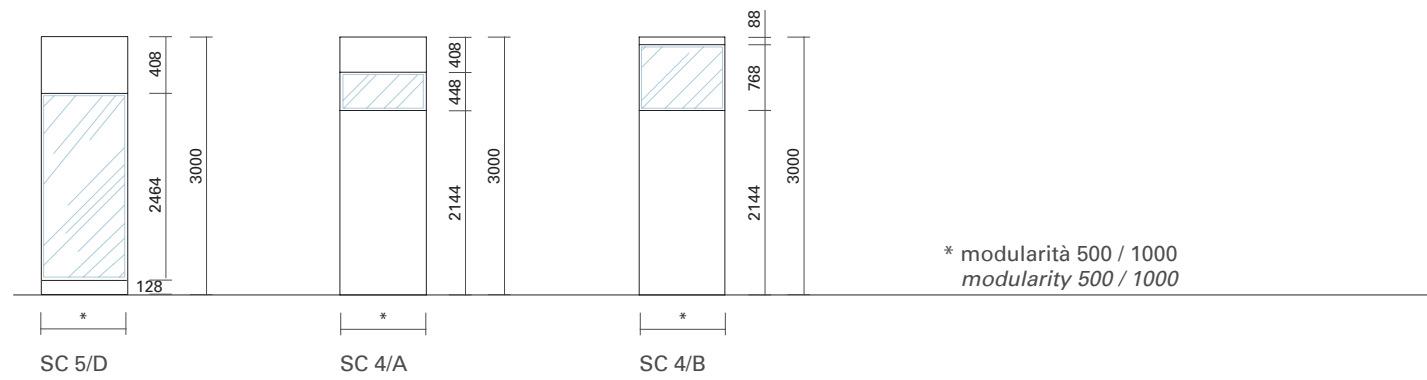
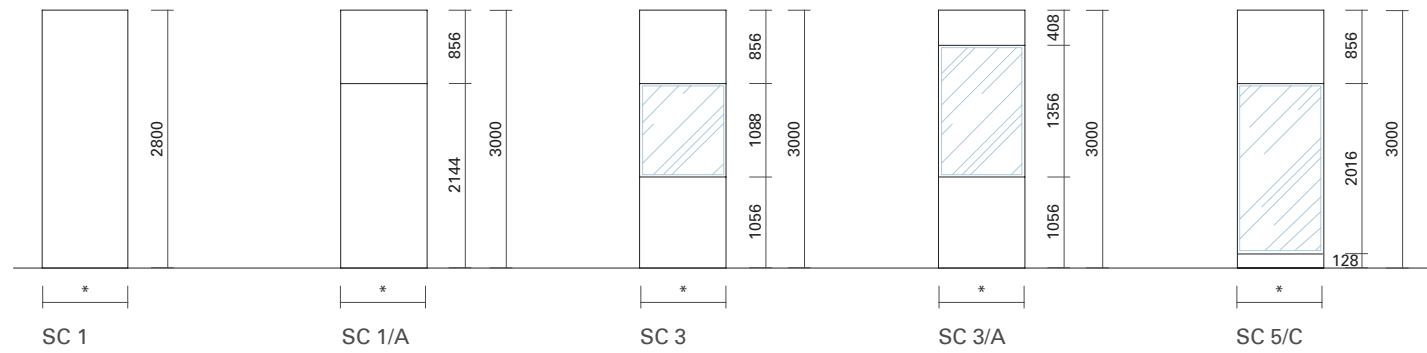

Moduli orizzontali / Horizontal modules

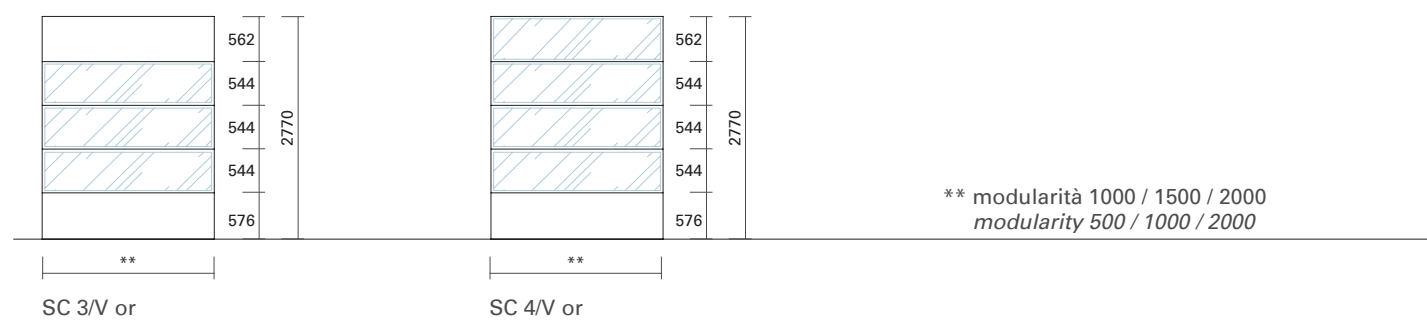
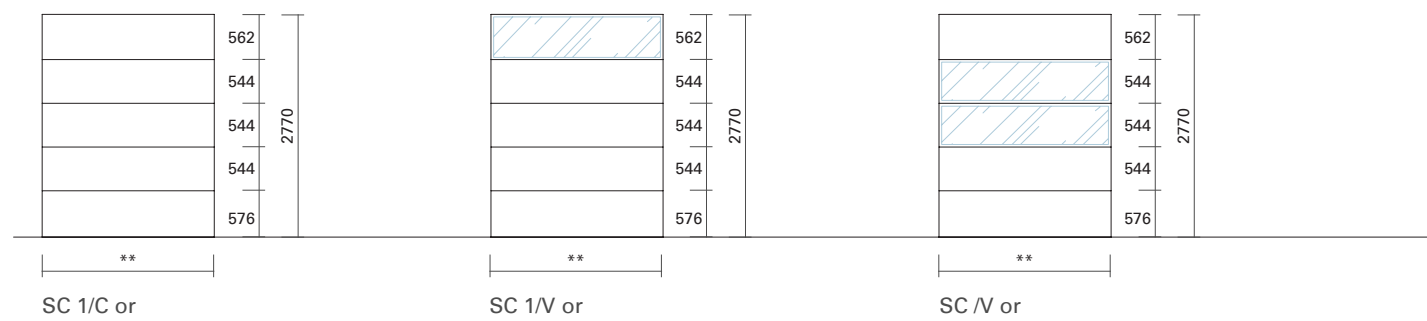

## . abaco porte / abaco doors

Moduli porte intelaiate H. 2144 mm. Vano di passaggio L. 900 mm /  
Framed doors modules H. 2144 mm. Pass-through width 900 mm

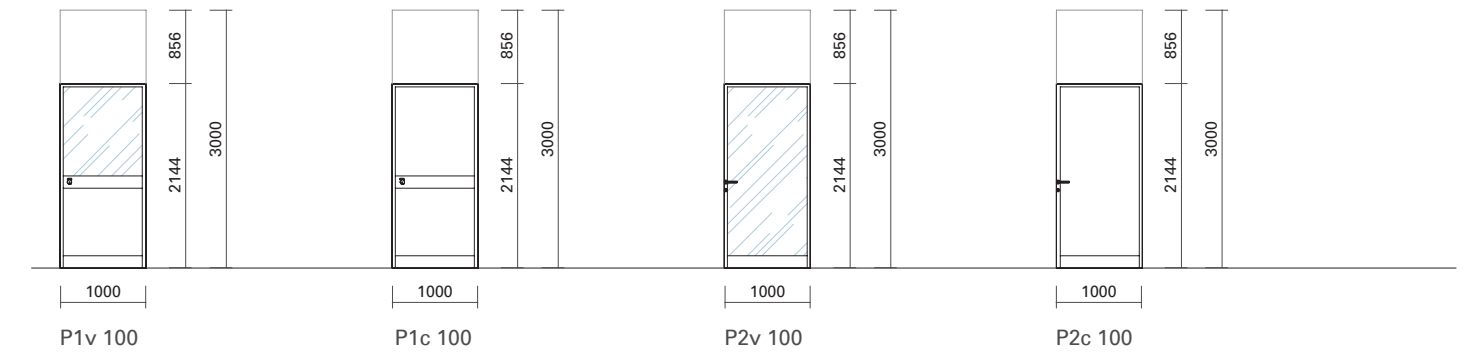

Moduli porte intelaiate H. 2592 mm. Vano di passaggio L. 900 mm /  
Framed doors modules H. 2592 mm. Pass-through width 900 mm

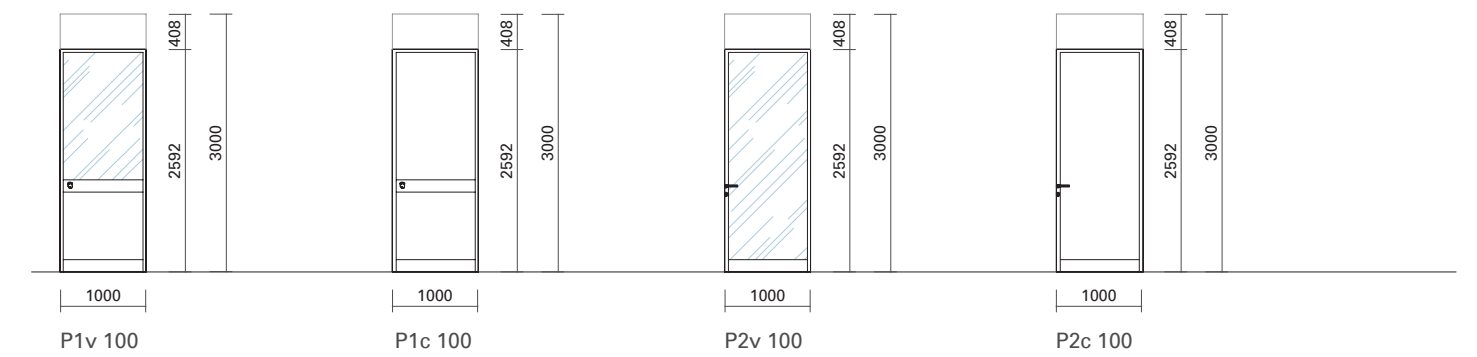

Moduli porte cieche tamburate /  
Frameless honeycomb doors modules

Moduli porte vetrate filo lucido /  
Glazed doors with polished edge modules

Moduli porte vetrate intelaiate minimal /  
Minimal framed glazed doors modules

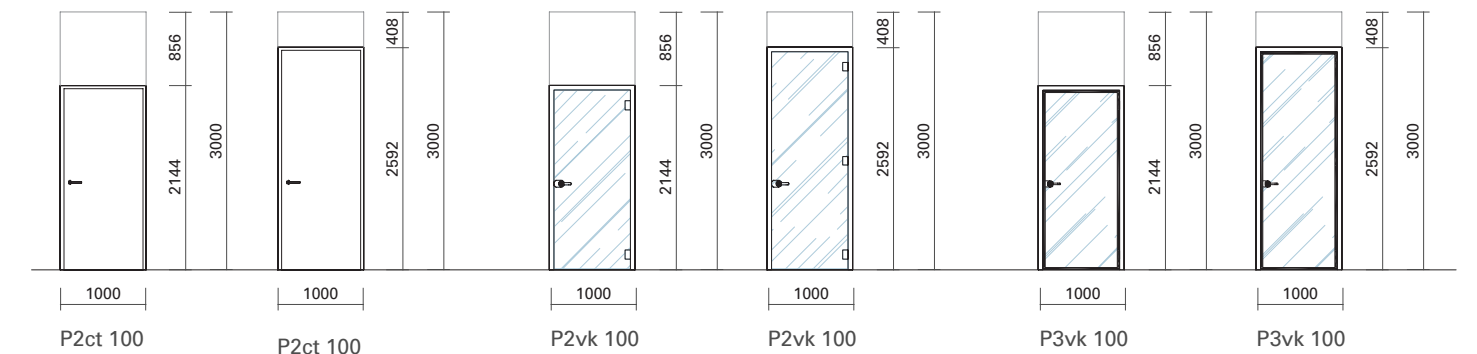

Dimensioni porte / Door dimensions

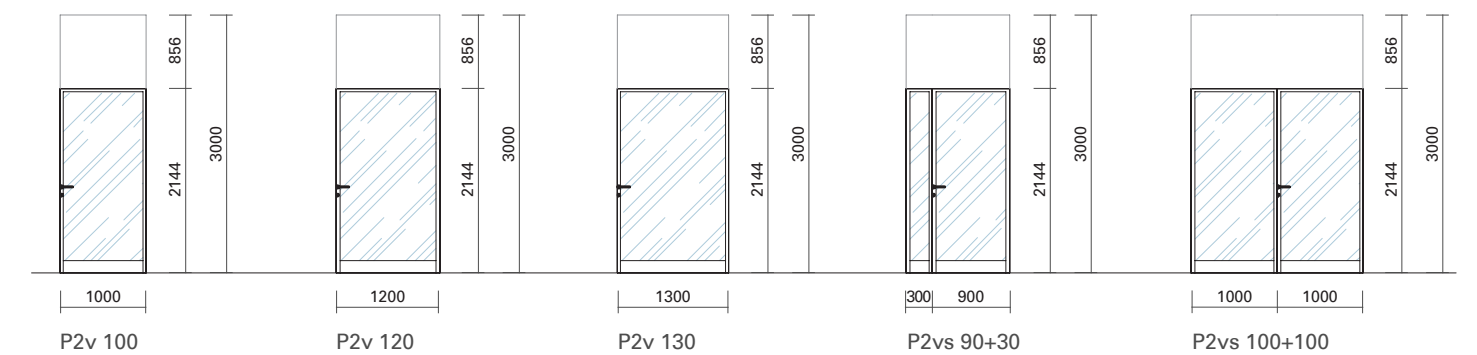



# SERIE

36G  
110SC  
470E  
80A-100B

Pareti divisorie attrezzate per ufficio: la parete attrezzata è composta da moduli componibili ed intercambiabili tra loro che permettono una separazione visiva e acustica dello spazio. Questo prodotto permette di creare in un unico ambiente diverse soluzioni d'arredo indipendenti tra loro.

I moduli possono essere allestiti in diversi modi (ripiani, cassetti, classificatori estraibili, appendiabiti, ante in vetro e molto altro) a seconda delle esigenze e dei gusti. È possibile creare allestimenti misti con armadi e pareti divisorie (serie 36G e serie 110SC), il tutto con finiture e caratteristiche simili e complementari.

*Storage partition walls: the wall system consists of modular and interchangeable partitions that provide visual and acoustic separation of space. With this system you can easily create multiple independent furnishing solutions in the same environment.*

*The modules can be fitted with shelves, drawers, pull out filing drawers, coat racks, glass doors and much more to arrange many different configurations, depending on the individual needs and tastes. Storage walls can be complemented with cabinets and partitions (36G and 110SC Series) to obtain a variety of adaptable settings, with similar and matching finishes and features.*







. moodboard



. 1 alluminio grigio opaco / *matt grey coated aluminium*  
 . 2 nobilitato / *melamine bianco extra*

. 3 vetro trasparente / *clear glass*  
 . 4 parquet









. moodboard



. 1 nobilitato / melamine P01 gessato grigio  
. 2 nobilitato / melamine 797 grafite

. 3 nobilitato / melamine 0K8 unimetallic metal  
. 4 gres porcellanato / porcelain stoneware









. moodboard



. 1 nobilitato / melamine **U6351 bianco extra**

. 2 vetro trasparente / *clear glass*

. 3 alluminio ossidato naturale / *natural anodized aluminium*

. 4 nobilitato / melamine **797 grafite**

. 5 pelle nera / *black leather*

. 6 parquet







. abaco Serie 470E

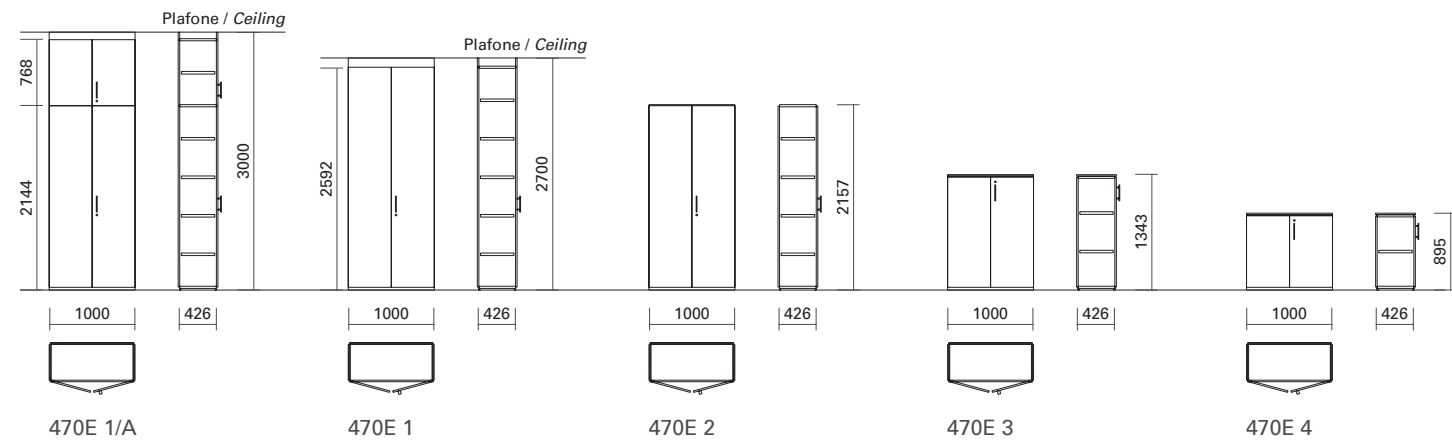

. abaco Serie 470E

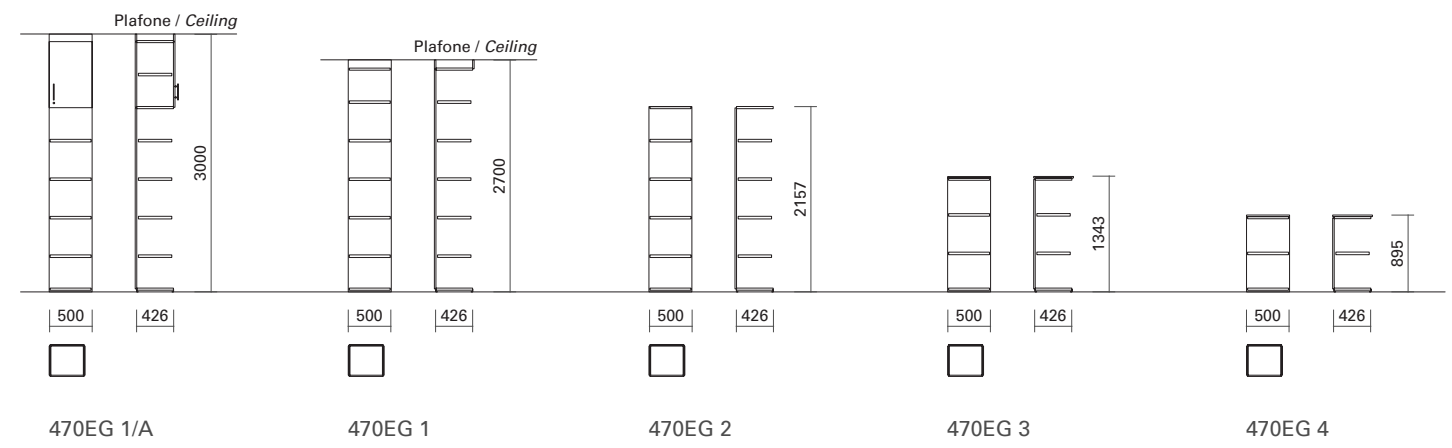
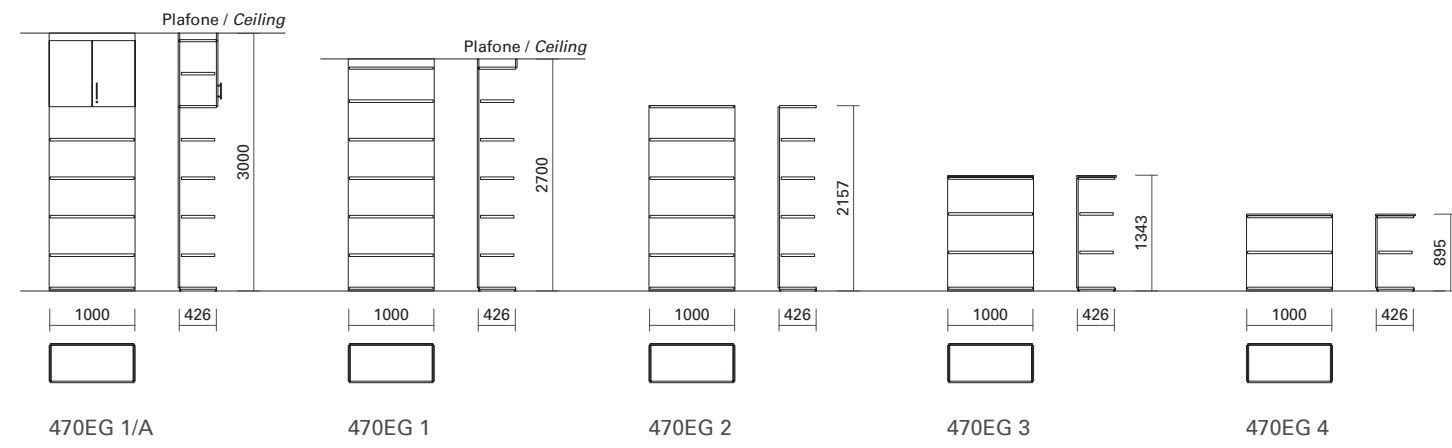
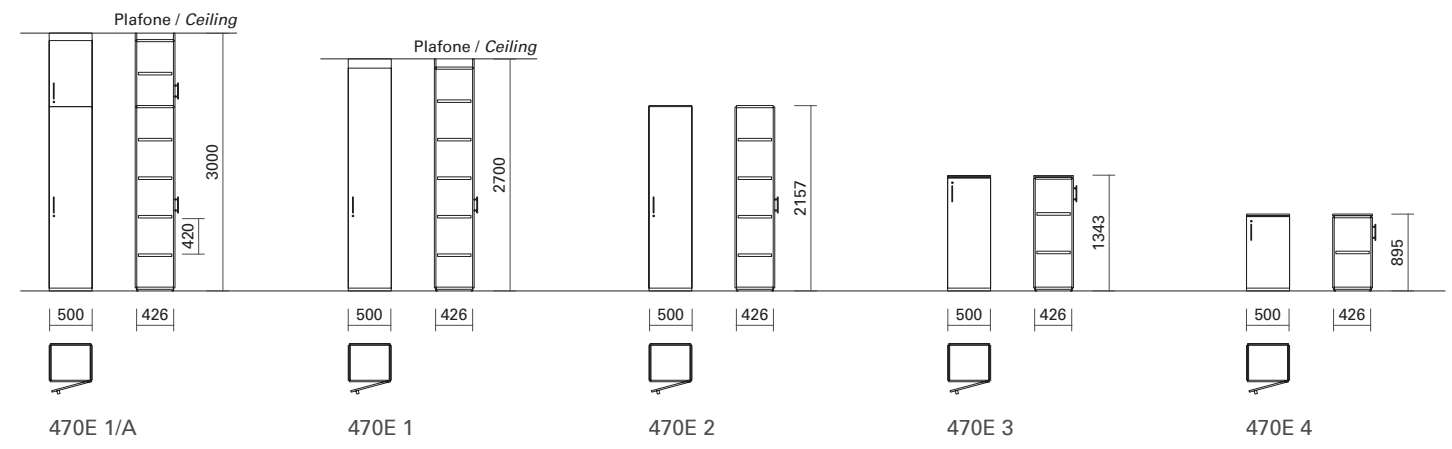
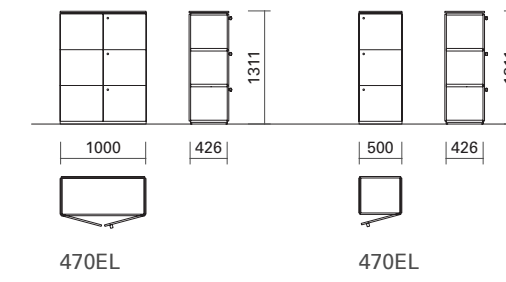



# SERIE

36G  
110SC  
470E  
80A-100B

Pareti divisorie economiche per ufficio: le pareti con coprifilo sono il nostro prodotto più economicamente competitivo; di semplice realizzazione e installazione rapida, vengono utilizzate per la creazione di box o cabine uffici con la peculiarità di modificare gli ambienti lavorativi con estrema velocità e semplicità.

In grado di adattarsi alle diverse caratteristiche degli spazi in cui viene installata, questa parete può anche essere modificata con facilità successivamente all'installazione.

*Best price office partitions: our partitions with covering profile are the most price competitive among our product range. Their simple construction and easy installation allow for a swift and effective redesign of your workplace, making them especially suited for cabin offices or booths.*

*The partitions can also be modified after installation to adapt to the different characteristics of the workspace.*







. dettagli tecnici / *technical specifications*

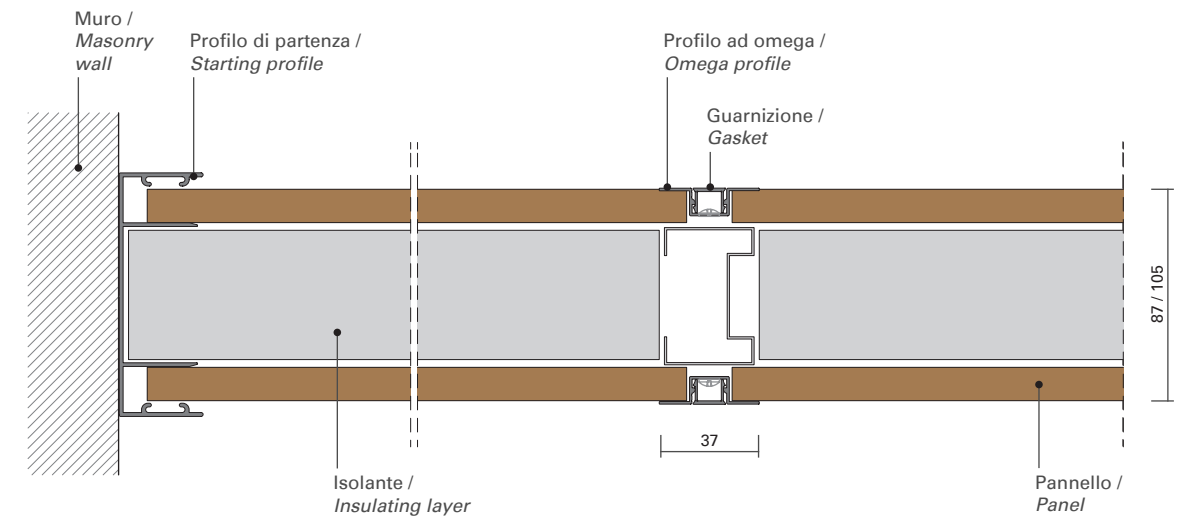

PARETE CIECA /  
FRAMELESS PARTITION

sezione orizzontale / *horizontal section*

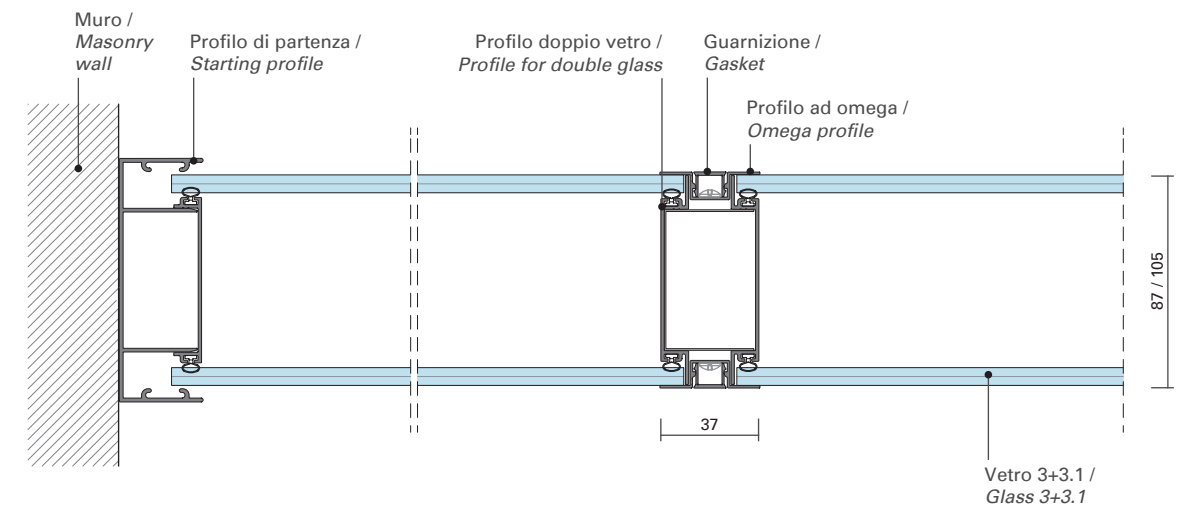

PARETE DOPPIO VETRO /  
DOUBLE GLAZED PARTITION

sezione orizzontale / *horizontal section*

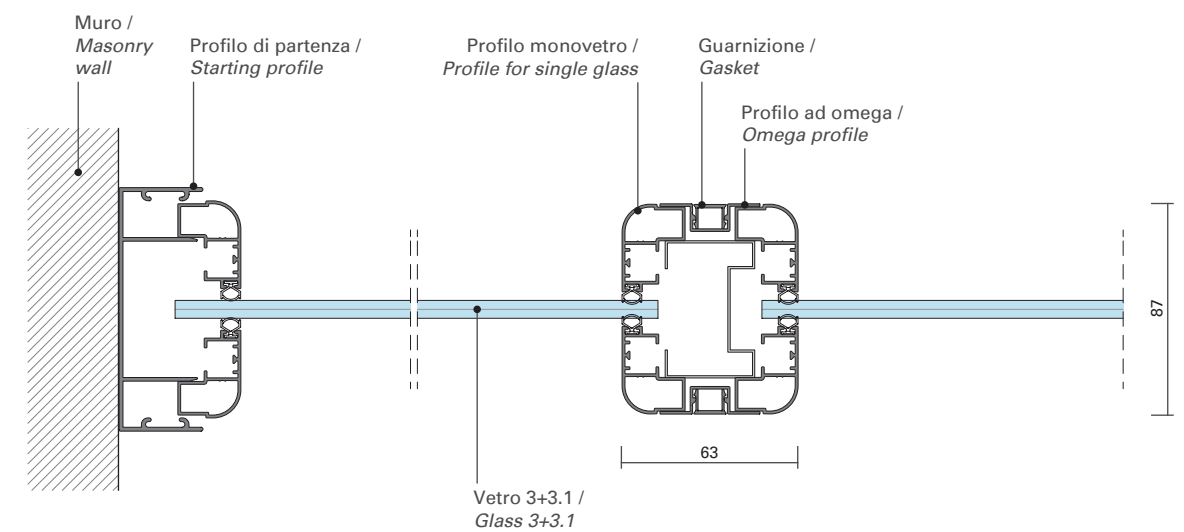

PARETE MONOVETRO /  
SINGLE GLAZED PARTITION

sezione orizzontale / *horizontal section*



. moodboard



. 1 vetro trasparente / *clear glass*

. 2 nobilitato / *melamine DK8 unimetallic metal*

. 3 alluminio nero opaco / *matt black coated aluminium*

. 4 cemento / *concrete*





. dettagli tecnici / *technical specifications*

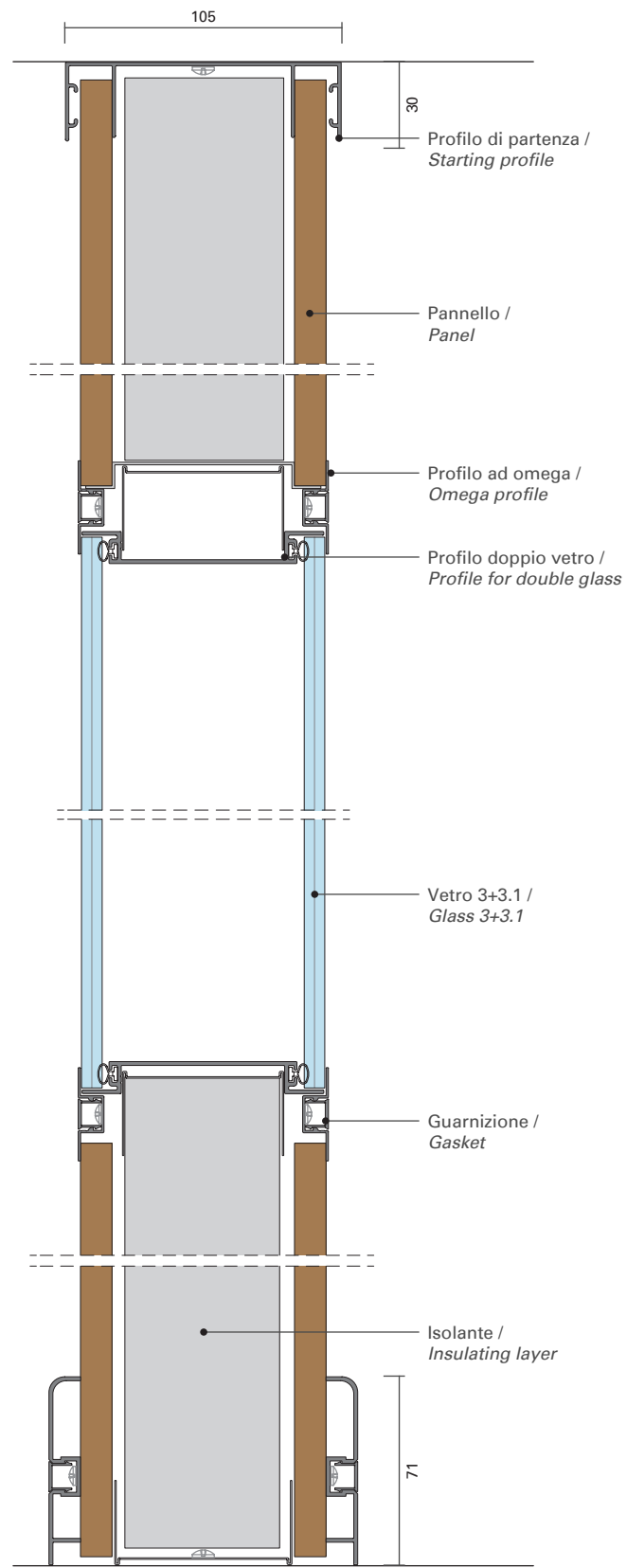

100 B  
sezione verticale / *vertical section*

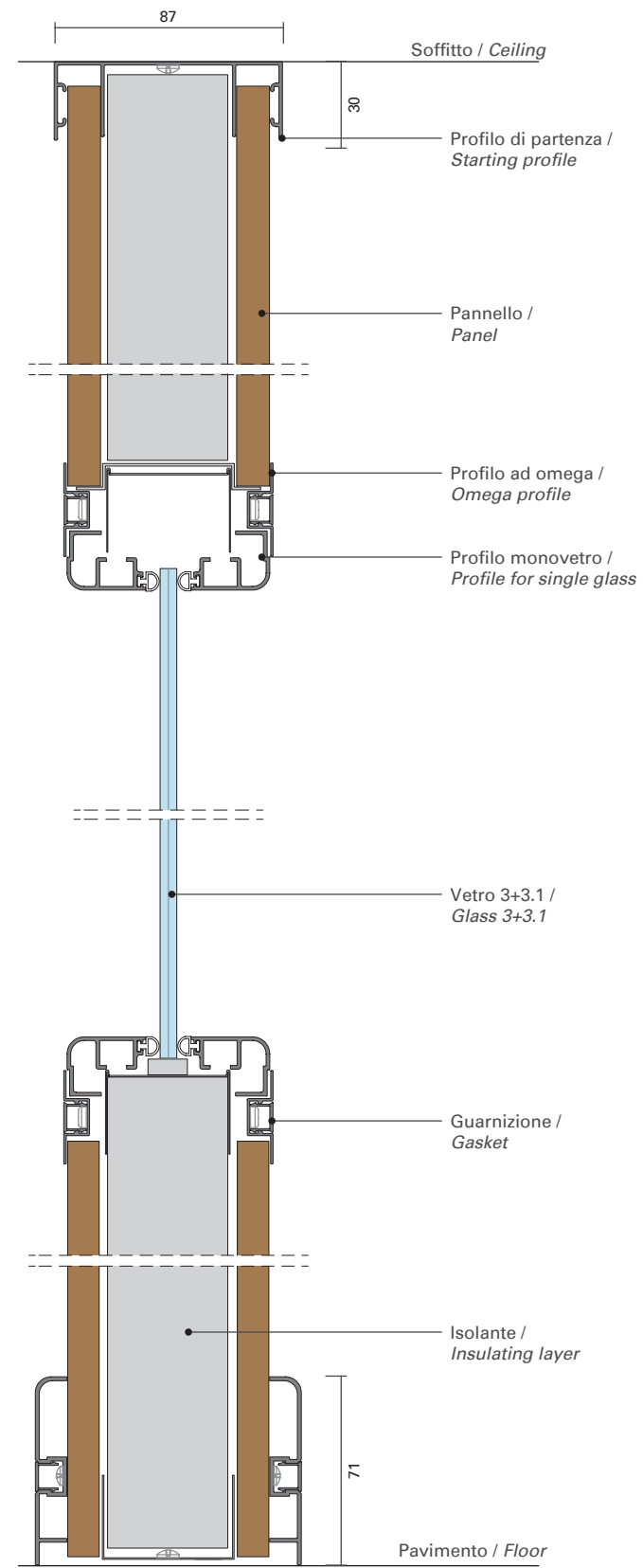

80 A  
sezione verticale / *vertical section*





. dettagli tecnici / *technical specifications*

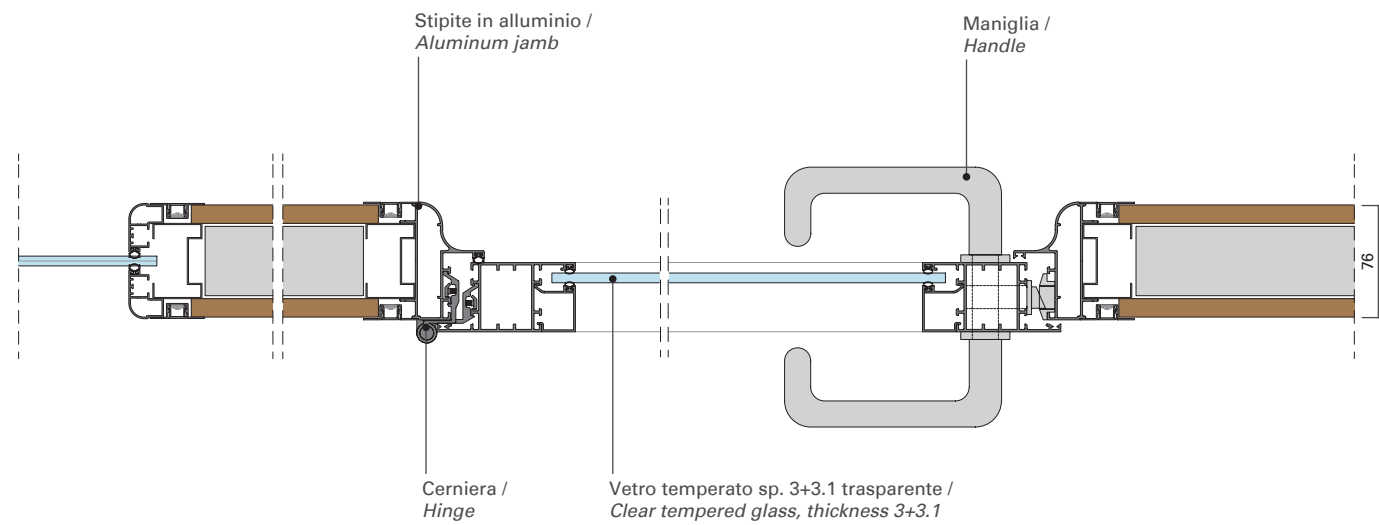

PORTA INTELAIATA VETRO SINGOLO /  
FRAMED SINGLE GLAZED DOOR

sezione orizzontale / *horizontal section*



. moodboard



. 1 nobilitato / **melamine U6375 grigio polvere**  
. 2 vetro trasparente / *clear glass*

. 3 alluminio ossidato naturale / *natural anodized aluminium*  
. 4 cemento / *concrete*

. abaco moduli 80A-100B / *abaco 80A-100B module*

Moduli standard / *Standard modules*

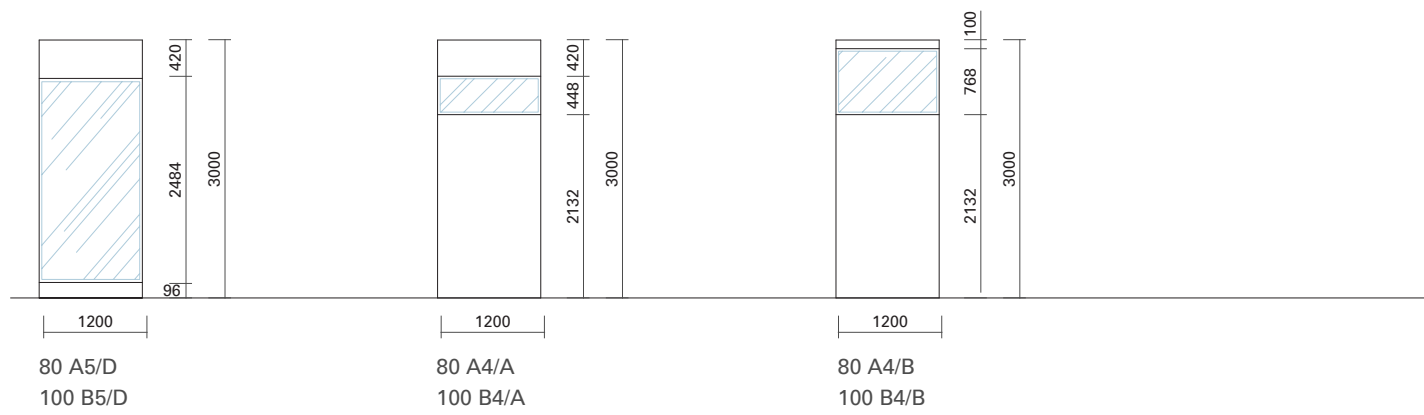
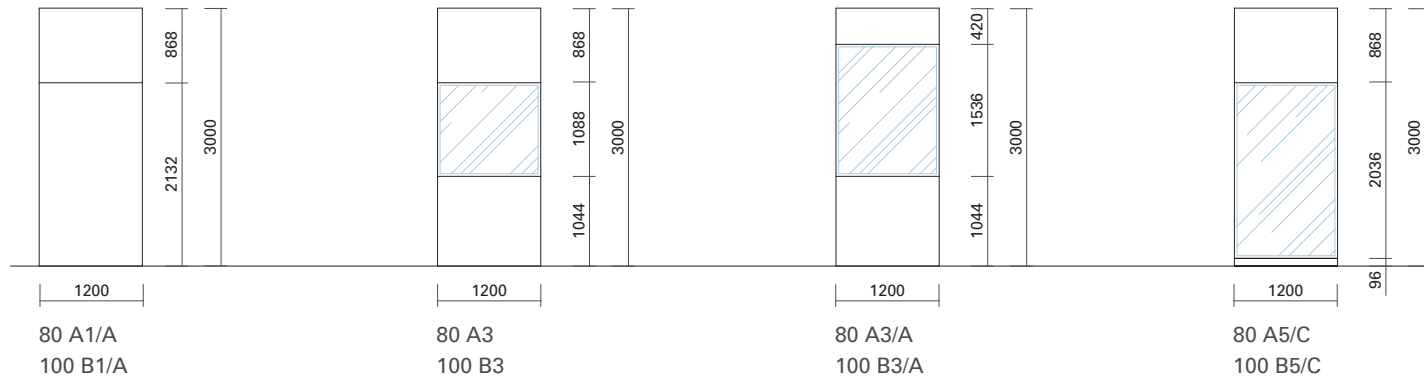

. abaco porte / *abaco doors*

Moduli porte intelaiate H. 2132 mm. Vano di passaggio L. 900 mm /  
Framed doors modules H. 2132 mm. Pass-through width 900 mm

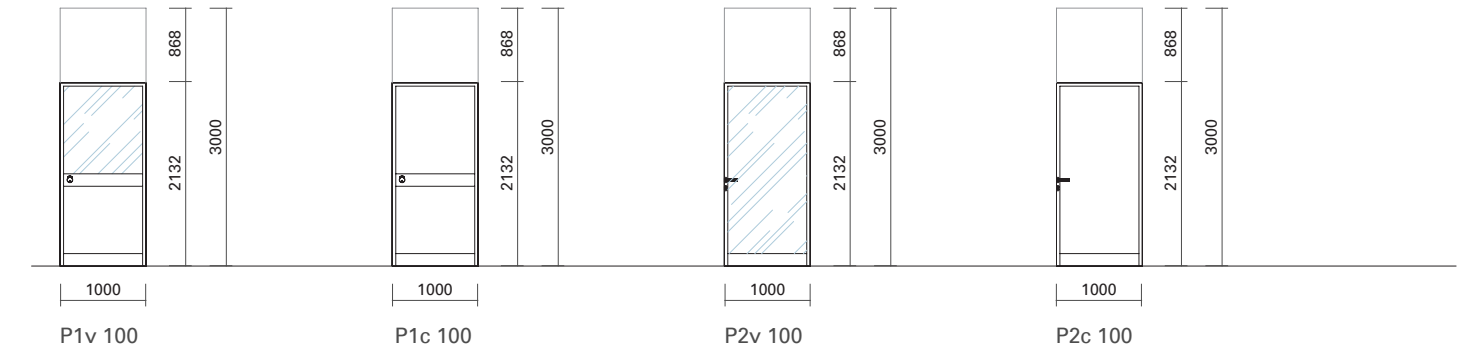

Moduli porte intelaiate H. 2580 mm. Vano di passaggio L. 900 mm /  
Framed doors modules H. 2580. Pass-through width 900 mm

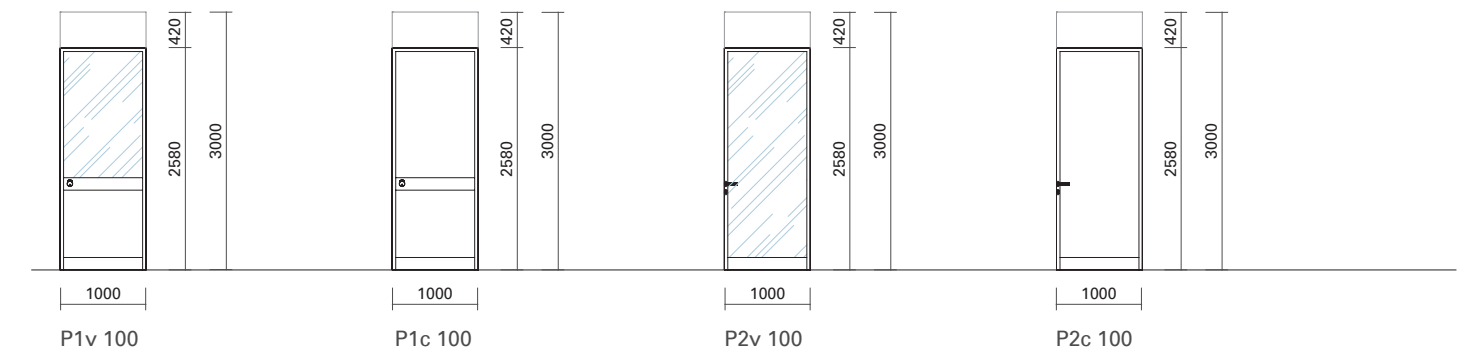

Dimensioni porte / *Door dimensions*

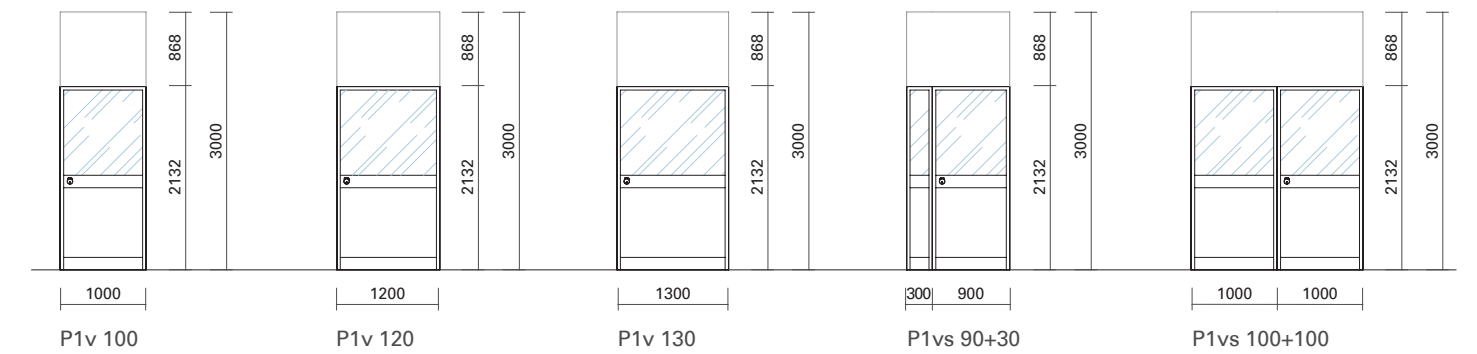



. finiture / finishes

. profili in alluminio / aluminium profiles



alluminio ossidato naturale /  
*natural anodized aluminium*



alluminio lucido /  
*polished aluminium*

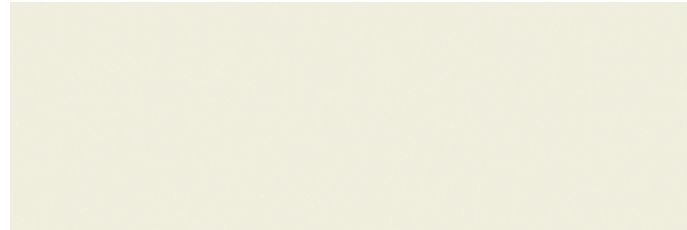

verniciato bianco opaco RAL 9010 /  
*RAL 9010 matt white*



verniciato nero opaco RAL 9005 /  
*RAL 9005 matt black*

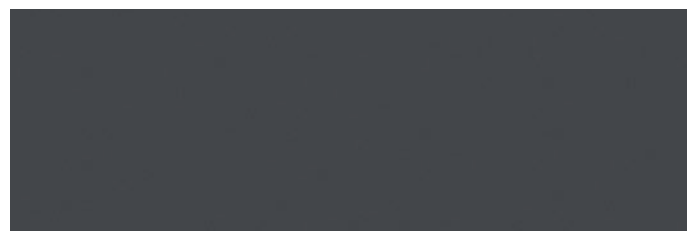

verniciato grigio opaco RAL 7016 /  
*RAL 7016 matt grey*

. vetri / glass panes



trasparente /  
*clear*



trasparente extralight /  
*extra-clear*

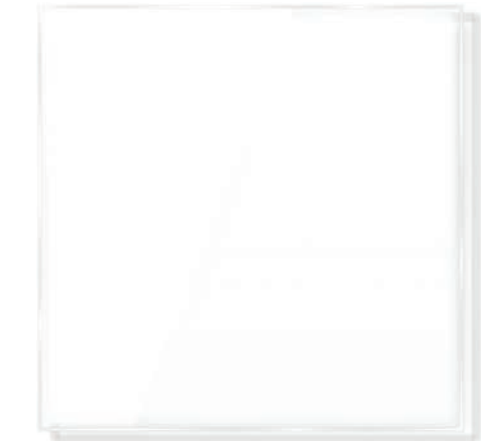

bianco latte /  
*white*



acidato /  
*etched*



grigio fumo /  
*smoked grey*



tortora /  
*dove-grey*

Le texture, i colori dei materiali e delle finiture hanno valore indicativo in quanto soggetti alle tolleranze dei processi di stampa.  
*Textures and colours of materials and finishes are indicative only, since they depend on the tolerances applicable to the printing process.*

. finiture / finishes

. nobilitati decorativi / decorative melamine veneers



OK8 unimetallic metal

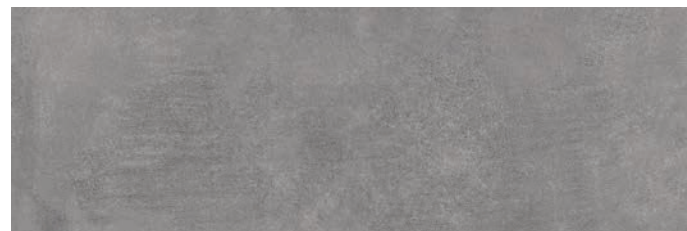

DN8 kena cemento

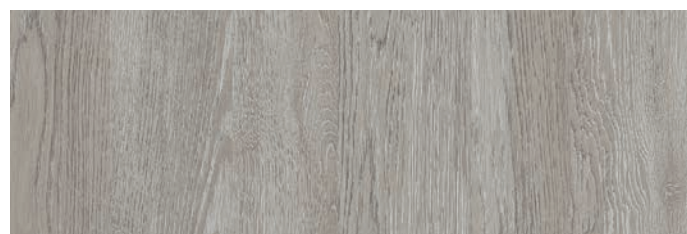

P01 gessato grigio



20M twist



DB1 nitens white

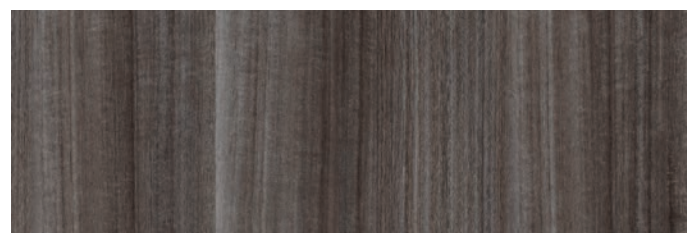

DB4 nitens dark

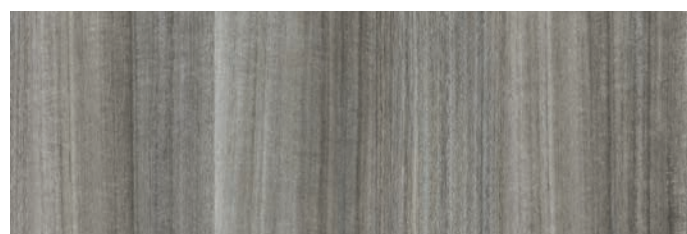

DB2 nitens grey

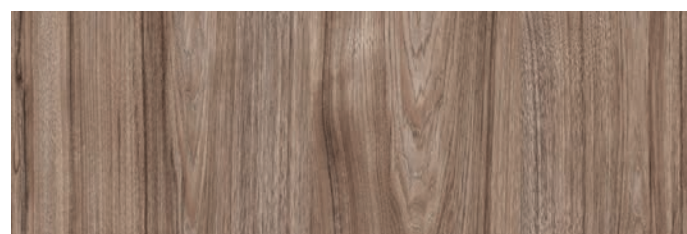

DR1 pecan naturale

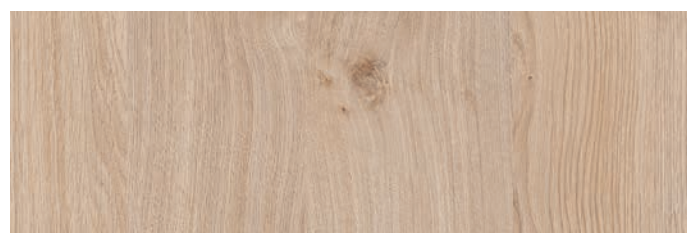

D72 eureka chiaro

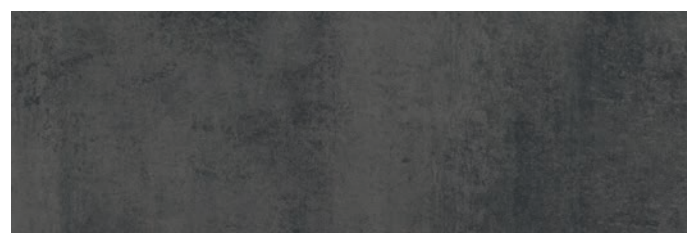

TR9 oxyd

. nobilitati tinta unita / solid colour melamine veneers

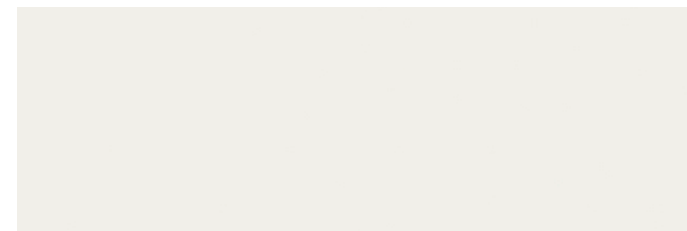

U6351 bianco extra



U6375 grigio polvere

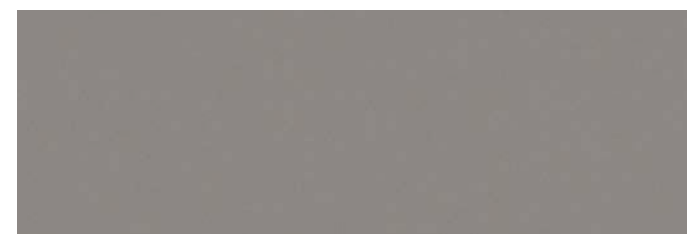

AP2 grigio



797 grigio grafite

Le texture, i colori dei materiali e delle finiture hanno valore indicativo in quanto soggetti alle tolleranze dei processi di stampa.  
Textures and colours of materials and finishes are indicative only, since they depend on the tolerances applicable to the printing process.



. maniglie / handles

. maniglie pareti Serie 80A-100B / handles for Series 80A-100B partitions



Europa

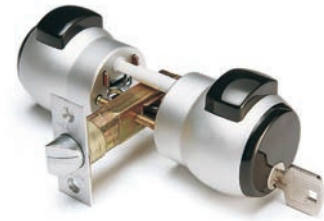

Nova PremiApri (chiave/nottolino) /  
Nova PremiApri (key/thumbturn)

. maniglie per pareti attrezzate / handles for storage walls



Fuji



Orlando

. maniglie per porte battenti / handles for swing doors



Paris legno (chiave/nottolino) /  
Paris wood (key/thumbturn)



Paris legno (chiave/nottolino) /  
Paris wood (key/thumbturn)

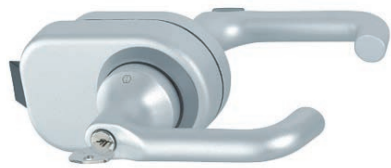

Paris vetro (chiave/nottolino) /  
Paris glass (key/thumbturn)



Paris vetro (chiave/nottolino) /  
Paris glass (key/thumbturn)



Arles complanare /  
Arles coplanar

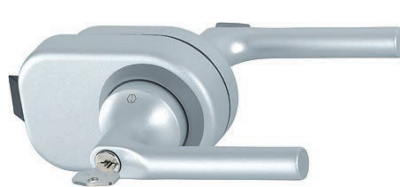

Arles (chiave/nottolino) /  
Arles (key/thumbturn)

. maniglioni / handle bars



DH25

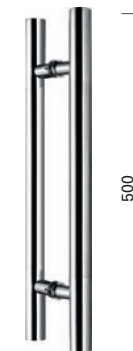

DH3A2

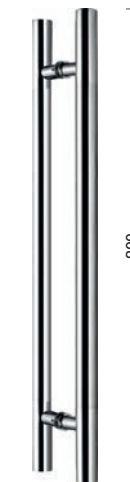

DH3D

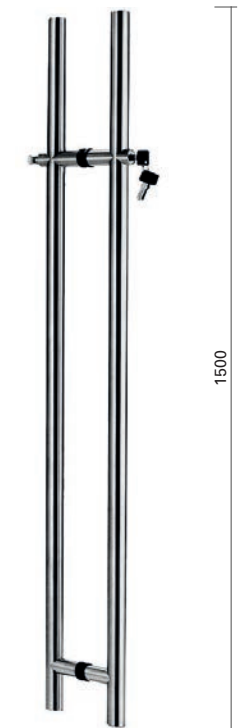

500W50

(con serratura chiave/nottolino) /  
(doorknob with key/thumbturn)

Art direction: Solutionstudio  
Image e styling: Solutionstudio

Printed in Italy  
2022-1 edition

L'azienda si riserva di modificare e migliorare le caratteristiche dei prodotti presenti in questo catalogo per poter soddisfare le esigenze di mercato.

Le texture, i colori dei materiali e delle finiture hanno valore *indicativo in quanto soggetti alle tolleranze dei processi di stampa.*

Per un esatto riferimento sulle specifiche dettagliate dei prodotti è consigliato l'uso della scheda tecnica.

*Fipe System reserves the right to make changes and improvements to the characteristics of the products shown in this catalogue in order to meet market requirements.*

*Textures and colours of materials and finishes are for reference only, since they depend on the tolerances applicable to the printing process.*

*Please refer to the technical data sheet for more detailed information on the products.*



Fipe System srl  
Via Guido Rossa, 6 20815 Cogliate (MB) Italy  
T +39 02 96469109 - F +39 02 96469889  
info@fipesystem.com - fipesystem.com





Fipe System srl  
Via Guido Rossa, 6 20815 Cogliate (MB) Italy  
T +39 02 96469109 - F +39 02 96469889  
info@fipesystem.com - fipesystem.com

---