

OFFIC'E'

LOFT

Rispetto dell'ambiente

Respect for the environment



ECONOMIA CIRCOLARE CIRCULAR ECONOMY

Produciamo strutture e ante in nobilitato costituite da pannelli ecologici provenienti da fornitori certificati FSC® che utilizzano legno pre e post-consumo a cui viene data una seconda vita in virtù di un'economia circolare che si autoalimenta, senza andare a intaccare il nostro patrimonio forestale.

We produce melamine-faced structures and doors consisting of ecological panels produced by FSC® certified suppliers who use pre- and post-consumer wood, which is given a second life thanks to a self-perpetuating circular economy, without impacting our existing forests.



MATERIALI ECO-FRIENDLY ECO-FRIENDLY MATERIALS

Utilizziamo vetro e alluminio, riciclabili all'infinito per realizzare prodotti resistenti e di grande impatto estetico, e PET per superfici sicure che non rilasciano alcuna emissione tossica durante il ciclo di produzione e utilizzo.

We use glass and aluminium, infinitely recyclable materials to develop resistant products with a high visual impact, and PET for safe surfaces without toxic emissions either during production or use.



DIAGNOSI ENERGETICA ENERGY DIAGNOSIS

Monitoriamo costantemente i consumi totali e definiamo azioni di miglioramento sistemico per ottimizzare il nostro impatto energetico.

We constantly monitor our total consumption and define systemic improvement actions to optimise our energy impact.



UNI EN ISO 14001 UNI EN ISO 14001

Abbiamo certificato il nostro sistema di gestione ambientale in conformità agli standard alla norma UNI EN ISO 14001.

We have certified our environmental management system in compliance with standard UNI EN ISO 14001.



DURABILITÀ DEI PRODOTTI PRODUCT DURABILITY

Progettiamo prodotti con una maggiore vita utile per ridurre i rifiuti e offrire alti standard qualitativi.

We design products that last longer to reduce waste and offer high quality standards.



TECNOLOGIE GREEN GREEN TECHNOLOGIES

Scegliamo materiali naturali al 100% resi straordinari da processi innovativi come la tecnologia di sinterizzazione che permette di creare pietre ceramiche senza l'utilizzo di colle e sostanze inquinanti.

We choose 100% natural materials with excellent performance thanks to the use of innovative processes such as sintering technology, allowing the creation of ceramic stones without using adhesives or polluting substances.



LOGISTICA INTERNA INTERNAL LOGISTICS

Abbiamo ottimizzato tutte le movimentazioni all'interno dell'azienda per ridurre al minimo lo spreco di risorse energetiche e la produzione di CO₂.

We have optimised all internal company logistics to reduce energy wastage and CO₂ production to a minimum.



IMBALLAGGI PACKAGING

Impieghiamo solo cartoni realizzati con carta riciclata, riducendo progressivamente l'uso della plastica per sostituirla completamente con materiali green.

We use only boxes made of recycled paper, gradually reducing the use of plastic, to be completely replaced with eco-friendly materials.



INNOVAZIONE INNOVATION

Siamo sempre alla ricerca di materiali e materie prime uniche che ci permettono di proporre sul mercato prodotti di alta qualità dal design distintivo.

We are always on the lookout for unique and raw materials allowing us to offer the market high-quality products with a signature design.



ATTITUDINE GREEN-LIVING GREEN-LIVING ATTITUDE

Abbiamo azzerato l'utilizzo della plastica negli uffici e nella produzione installando distributori d'acqua e recuperiamo tutti i rifiuti che produciamo con la nostra attività industriale.

We have eliminated the use of plastic in our offices and production department by installing water dispensers, and recover all the waste we produce through our industrial activities.



TRASPORTO TRANSPORT

Organizziamo le spedizioni ottimizzando gli spazi e i percorsi delle consegne per ridurre le emissioni di CO₂ sul pianeta.

We organise shipments by optimising space and delivery routes to reduce CO₂ emissions on the planet.



OTTIMIZZAZIONE DEGLI SPAZI SPACE OPTIMISATION

Riduciamo lo spreco dei materiali da costruzione ottimizzando gli spazi con le nostre soluzioni di arredo che si adattano alle diverse architetture grazie alla loro ampia modularità e personalizzazione.

We reduce building material waste by optimising spaces with our own furniture solutions, perfectly adaptable to different architectures thanks to their extensive modularity and customisation.

Loft è Plus

La semplicità è sintesi
Simplicity is synthesis
La sencillez es síntesis
La simplicité est synthèse

La forma è versatile e si integra nella misura degli spazi; rafforza il progetto con il suo carattere. L'utilizzo diventa organizzato e semplice.

The shape is versatile and integrates into the measure of the spaces; strengthens the project with its character. Use becomes organized and simple.

La forma es versàtil y se integra a la medida de los espacios; fortalece el proyecto con su carácter. El uso se vuelve organizado y simple.

La forme est polyvalente et s'intègre dans la mesure des espaces; renforce le projet par son caractère. L'utilisation devient organisée et simple.



Il Grigio Titanio entra a far parte dell'offerta colore per le strutture della scrivania.

Grigio Titanio is added to the available colours for the desk structure.

Grigio Titanio pasa a formar parte de la oferta de colores para las estructuras de los escritorios.

Grigio Titanio entre faire partie de l'offre de couleurs pour les structures du bureau.

Loft è Plus perchè ha dieci finiture per il piano in melaminico e tre per il piano in vetro.

Loft is Plus because it has ten finishes for the melamine top and three for the glass top.

Loft es Plus porque tiene diez acabados para la parte superior en melamina y tres para la superficie en cristal.

Loft est Plus parce qu'il dispose de dix finitions pour le plateau en mélaminé et trois pour le plateau en verre.

Grigio Titanio, Cemento Masdar e Canapa, sono i nuovi colori in palette per la cassetiera. Top, cassa, cassetti, sono disponibili in tutte le tre finiture.

Grigio Titanio, Cemento Masdar and Canapa are the new colours now available for the chest of drawers. Top, carcass, drawers, are available in all three finishes.

Grigio Titanio, Cemento Masdar y Canapa son la nueva paleta de colores para la cómoda. Top, cajón, cajones, están disponibles en todos los acabados.

Grigio Titanio, Cemento Masdar et Canapa sont les nouvelles couleurs disponibles pour le meuble à tiroirs. Plateau, caisson, tiroirs sont disponibles dans les trois finitions.

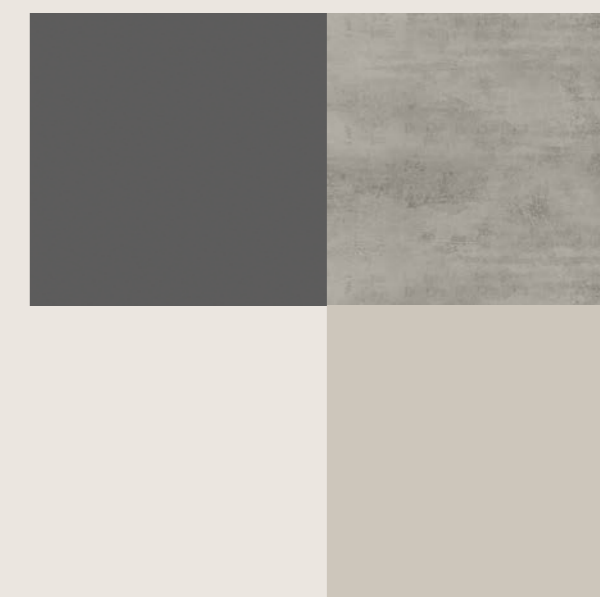

Mobile di servizio con elemento 30°

Cabinet with 30° element
Mueble de servicio con elemento 30°
Meuble de service avec élément 30°



I Colori



Il nuovo mobile di servizio e l'elemento 30° si presentano in tutte le dieci finiture del piano.

The new service unit and the 30° element are presented in all ten of the top finishes.

El nuevo mueble de servicio y el elemento 30° se presentan en los diez acabados de la parte superior.

Le nouveau meuble de service et l'élément 30° sont disponibles dans les dix finitions du plateau.

Quindici sono le combinazioni di finitura cassa e ante; alle dieci offerte per il piano, si aggiungono cinque colori moda. Anche la schiena può essere scelta tra queste.

There are fifteen combinations of carcass and door finishes; five fashionable colours are added to the existing ten for the top. These can also be selected for the back panel.

Son quinze las combinaciones del acabado del cajón y las puertas; a las diez para la parte superior, se añaden cinco colores de moda. La parte posterior también se puede elegir entre estos.

Les combinaisons de finition du caisson et des portes sont au nombre de quinze; aux dix offertes pour le plateau, s'ajoutent cinq couleurs mode. Le panneau arrière peut lui aussi être choisi ces couleurs.



SIMPLY TOP

Solamente il meglio

Only the best

Solo lo mejor

Seulement le meilleur

































UNDERGROUND

Assolutamente metropolitano

Absolutely metropolitan

Absolutamente metropolitano

Absolument métropolitain







MY LIFE
DESIGN
STORIES
DEFINITIONS OF THE
CONTEMPORARY HOME.















CITY ON

Uno sguardo sopra la città

A look over the city

Una mirada sobre la ciudad

Un regard au-dessus de la ville



























LIGHTNESS

Luminoso e leggero
Bright and light
Brillante y ligero
Lumineux et léger





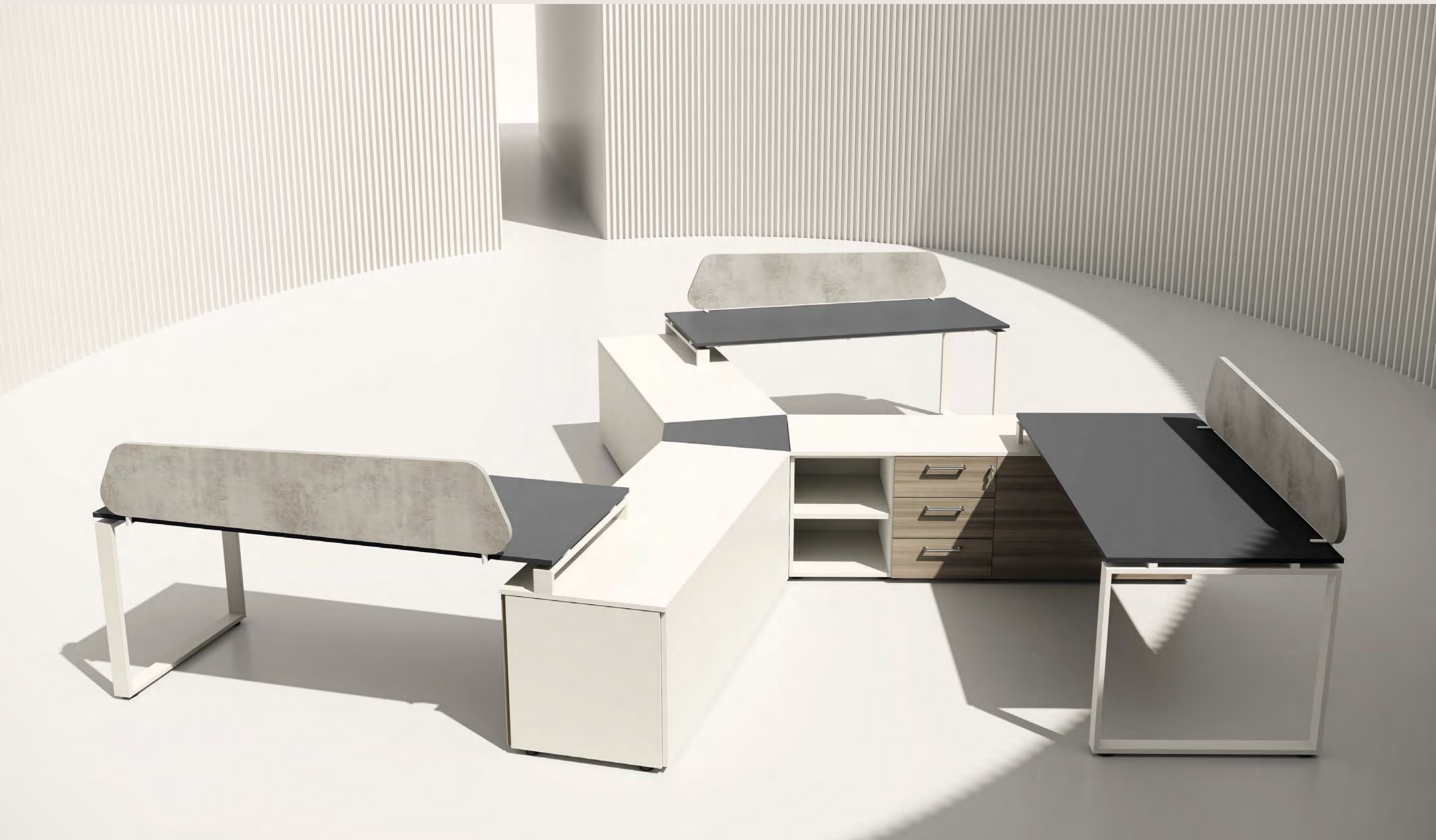



















Informazioni tecniche

Technical information
Informaciones técnicas
Informations techniques

Scrivanie, workstation e bench

Desks, workstation and bench / Escritorios, workstation y bench / Bureaux, workstation et banc



Scrivanie

Desks / Escritorios / Bureaux

L	P	H
80		
100		
120	60 - 80	75 - 75,7
140	160,8	
160		
180		
200		
200	100	75 - 75,7

Workstation

Workstation / Workstation / Workstation

L	P	H
160	160	75 - 75,7

Piani in melaminico

Melamine tops / Encimeras en melaminico / Plans en mélamine

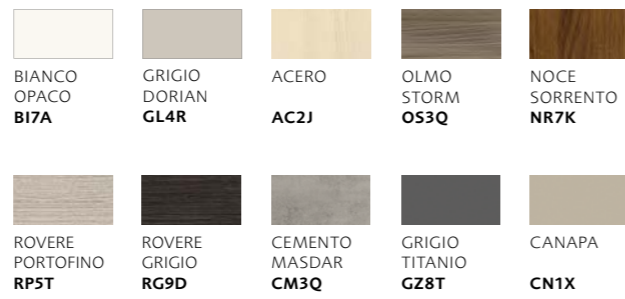
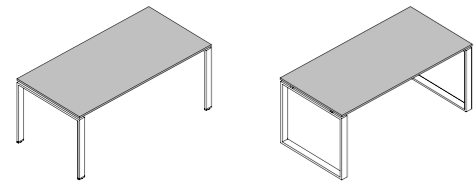

Piani in vetro

Glass tops / Tableros de vidrio / Plans en verre

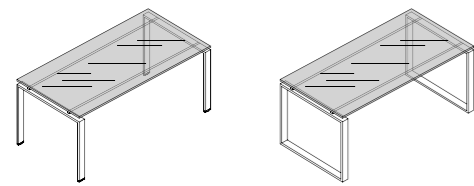

Sostegni

Supports / Soportes / Supports

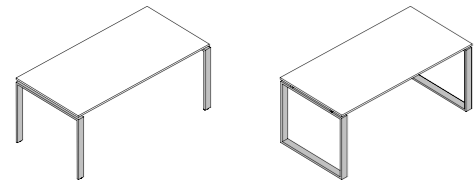

Schermi divisori e modesty panel

Divider screens and modesty panel / Pantallas divisorias y panel modesty / Cloisons de séparation et panneaux modesty



Schermi in melaminico

Melamine screens / Pantallas de melamina / Écrans en mélaminé

L	P	H
60		
80		
100		
120	1,8 - 2,5	29,7 - 32,2
140		
160		
180		
200		

Schermi fonoassorbenti

Sound-absorbing screen / Pantallas fonoabsorbentes / Écrans acoustiques

L	P	H
80		
120	3	29,5 - 40
160		

Modesty panel

Modesty panel / Modesty panel / Panneau modesty

L	P	H
60		
80		
100		
120	1,8 - 2,5	44,7 - 72,2
140		
160		
180		

Schermo divisorio lineare/sagomato e modesty panel lineare/sagomato in melaminico

Melamine linear/shaped divider screen and linear/shaped modesty panel / Pantalla divisoria lineal/conformada y panel modesty lineal/conformado de melamina / Cloison de séparation linéaire/façonné et panneau modesty linéaire/façonné en mélamine

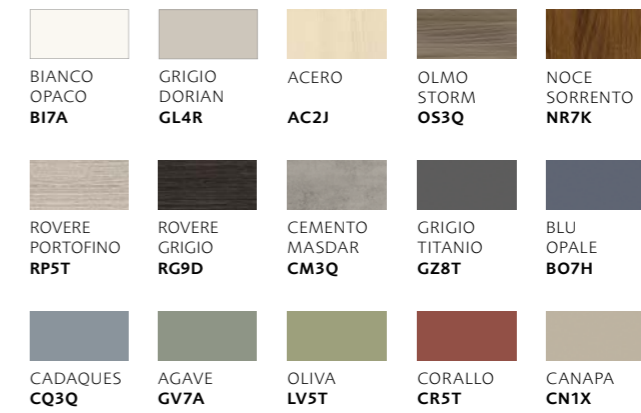
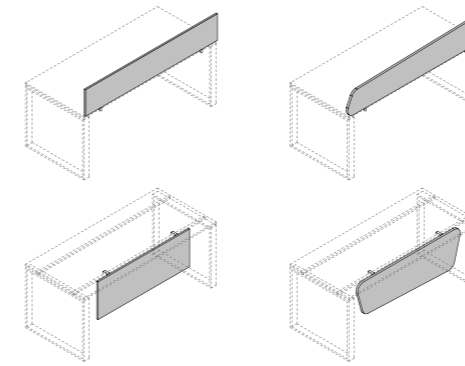

Schermo divisorio fonoassorbente in tessuto

Sound-absorbing fabric divider screen / Pantalla divisoria de tela de absorción de sonido / Cloison de séparation de tissu insonorisant

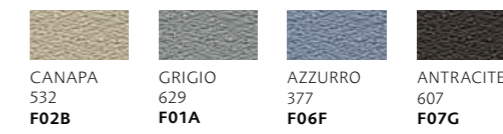
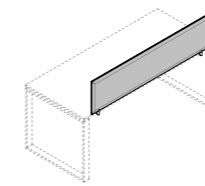

Modesty panel lineare a terra in melaminico

Melamine linear floor standing modesty panel / Panel modesty lineal de suelo de melamina / Panneau modesty linéaire au sol en mélamine

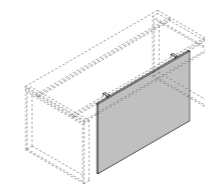

Cassettiere base

Bases with drawers / Bases con cajones / Bases avec tiroirs



Cassettiere

Drawer units / Cajoneras / Caissons à tiroirs

L	P	H
41,8	56,4 - 79,6	73,2

Cassa e frontali

Carcase and front panels / Estructura y frentes / Caisson et façades

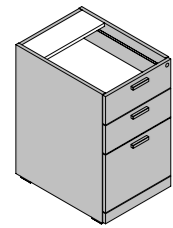

BIANCO OPACO B17A	GRIGIO DORIAN GL4R	ACERO AC2J	OLMO STORM OS3Q	NOCE SORRENTO NR7K
ROVERE PORTOFINO RP5T	ROVERE GRIGIO RG9D	CEMENTO MASDAR CM3Q	GRIGIO TITANIO GZ8T	CANAPA CN1X

Top di finitura

Finishing top / Encimera de acabado / Top de finition

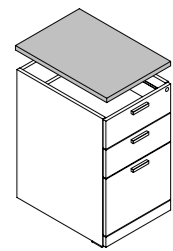

BIANCO OPACO B17A	GRIGIO DORIAN GL4R	ACERO AC2J	OLMO STORM OS3Q	NOCE SORRENTO NR7K
ROVERE PORTOFINO RP5T	ROVERE GRIGIO RG9D	CEMENTO MASDAR CM3Q	GRIGIO TITANIO GZ8T	CANAPA CN1X

Mobili Swing

Swing units / Muebles Swing / Meubles Swing



L	P	H
144	59,7	62,5

Cassa

Carcase / Estructura / Structure

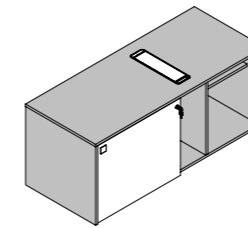

BIANCO OPACO B17A	GRIGIO DORIAN GL4R	ACERO AC2J	OLMO STORM OS3Q	NOCE SORRENTO NR7K
ROVERE PORTOFINO RP5T	ROVERE GRIGIO RG9D	CEMENTO MASDAR CM3Q	GRIGIO TITANIO GZ8T	CANAPA CN1X

Facciate

Fronts / Frentes / Façades

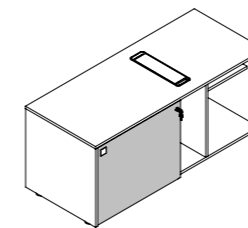

BIANCO OPACO B17A	GRIGIO DORIAN GL4R	ACERO AC2J	OLMO STORM OS3Q	NOCE SORRENTO NR7K
ROVERE PORTOFINO RP5T	ROVERE GRIGIO RG9D	CEMENTO MASDAR CM3Q	GRIGIO TITANIO GZ8T	BLU OPALE BO7H
CADAQUES CQ3Q	AGAVE GV7A	OLIVA LV5T	CORALLO CR5T	CANAPA CN1X

Mobili di servizio

Service units / Muebles de servicio / Meubles de service



L	P	H
91,9	59,7	62,5
136,8		
181,8		

Elemento 30°
30° element / elemento 30 /
élément 30°

L	P	H
60,1	57,7	62,5

Top

Top / Encimera / Top

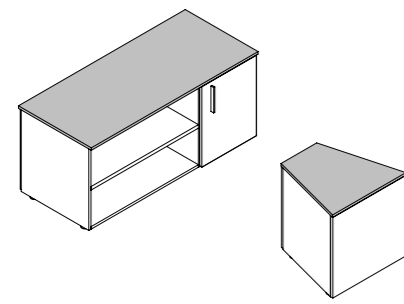

Cassa

Carcase / Estructura / Structure

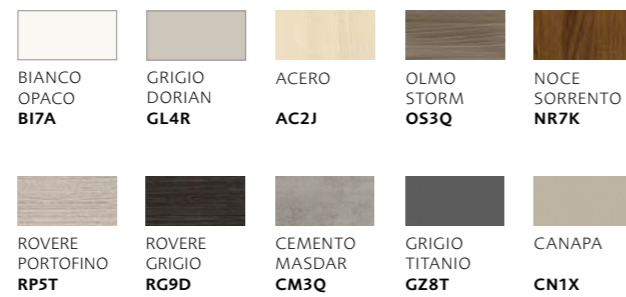
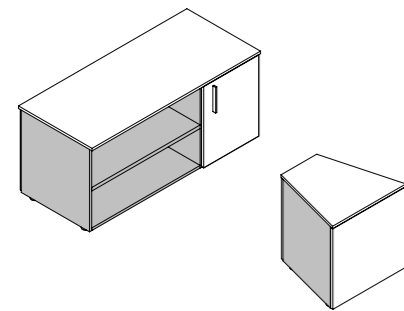

Ante e retro

Doors and rear / Puertas y parte posterior / Portes et fond

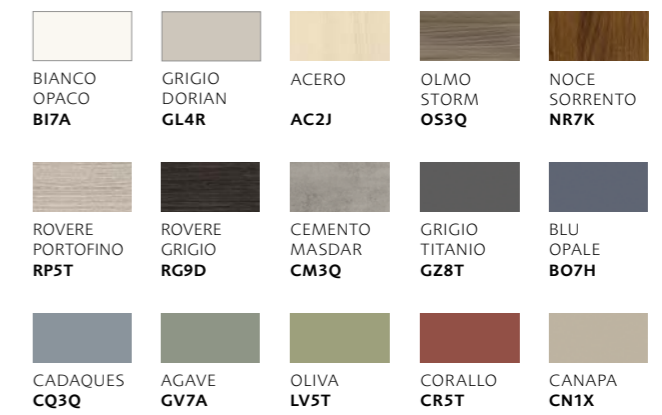
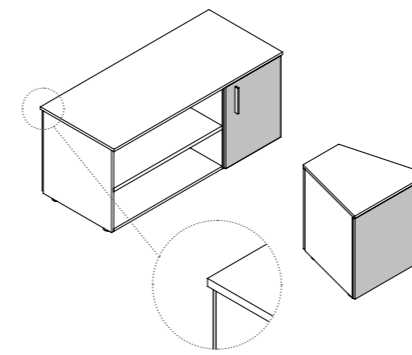

Cassetti

Drawers / Cajones / Tiroirs

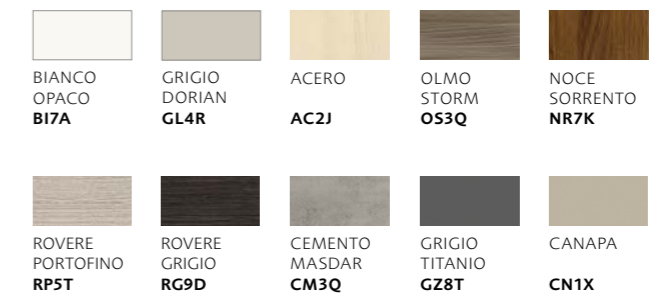
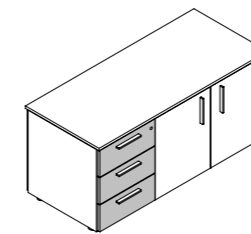

Cuscini per mobili portanti

Cushions for supporting elements / Cojines para muebles portantes / Coussins pour meubles porteurs

Cuscini P 57 in tessuto Jenny. Sfoderabili

Cushions D 57 in Jenny fabric. Removable covers / Cojines P 57 en tejido Jenny. Desenfundables / Coussins P 57 en tissu Jenny. Déhoussables

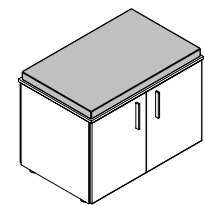

Mobili Bridge

Bridge units / Muebles Bridge / Meubles Bridge



L	P	H
145,2	39,4	112,5
166		

Cassa

Carcase / Estructura / Structure

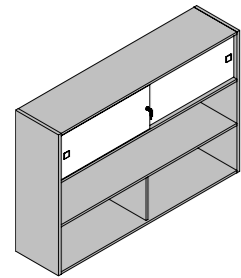

BIANCO OPACO B17A	GRIGIO DORIAN GL4R	ACERO AC2J	OLMO STORM OS3Q	NOCE SORRENTO NR7K
ROVERE PORTOFINO RP5T	ROVERE GRIGIO RG9D	CEMENTO MASDAR CM3Q	GRIGIO TITANIO GZ8T	CANAPA CN1X

Schiena

Back panel / Parte posterior / Panneau arrière

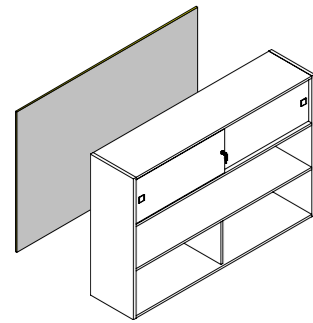

BIANCO OPACO B17A	GRIGIO DORIAN GL4R	ACERO AC2J	OLMO STORM OS3Q	NOCE SORRENTO NR7K
ROVERE PORTOFINO RP5T	ROVERE GRIGIO RG9D	CEMENTO MASDAR CM3Q	GRIGIO TITANIO GZ8T	CANAPA CN1X

Facciata

Front / Frente / Façade

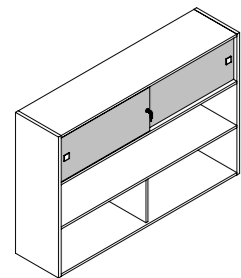

BIANCO OPACO B17A	GRIGIO DORIAN GL4R	ACERO AC2J	OLMO STORM OS3Q	NOCE SORRENTO NR7K
ROVERE PORTOFINO RP5T	ROVERE GRIGIO RG9D	CEMENTO MASDAR CM3Q	GRIGIO TITANIO GZ8T	BLU OPALE BO7H
CADAQUES CQ3Q	AGAVE GV7A	OLIVA LV5T	CORALLO CR5T	CANAPA CN1X

Maniglie

Handles / Tiradores / Poignées

U13G
P11

Legno
Wood
Madera
Bois

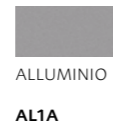

U16S
PIN

Alluminio
Aluminium
Aluminium
Aluminium

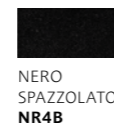
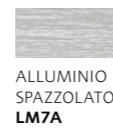

U00V
LIG

ABS



U15A
BIS

Alluminio
Aluminium
Aluminium
Aluminium

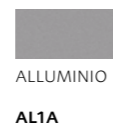

U11E
PUL

Legno
Wood
Madera
Bois

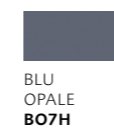
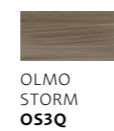
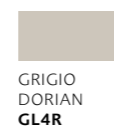

U10K
ROD

Alluminio + ABS
Aluminium + ABS
Aluminium + ABS
Aluminium + ABS

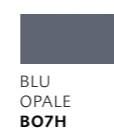

Maniglie

Handles / Tiradores / Poignées

U02B
SNIP

Alluminio
Aluminium
Aluminium
Aluminium

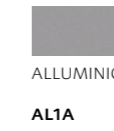

U09Z
RAN

Alluminio
Aluminium
Aluminium
Aluminium

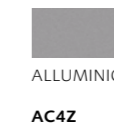

U12F
VIM

Legno
Wood
Madera
Bois

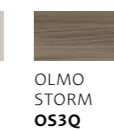
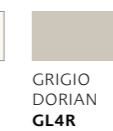

U17V
BUL

Alluminio
Aluminium
Aluminium
Aluminium

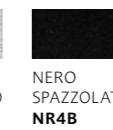
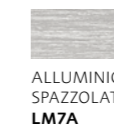

V20A
PUSH-PULL

Alluminio
Aluminium
Aluminium
Aluminium

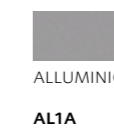

Accessori

Accessories / Accesorios / Accessoires

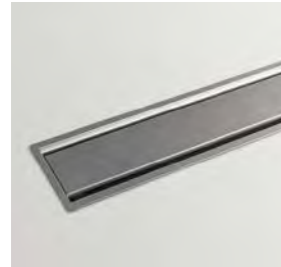

Top access
Access top
Top access
Top access



Passacavo elettrificato con
ricarica wireless
Electrified cable grommet
with wireless charging



Pasacable electrificado con
recarga inalámbrica
Passe-câble électrifié avec
recharge sans fil



Torretta elettrificata
Wired tower
Torreta electrificada
Bloc prises



Ricarica wireless
Wireless charge
Recarga wireless
Chargeur sans fil



Doppia presa usb
Double USB socket
Doble toma usb
Double prise usb



Accessorio multipresa
Multi-socket accessory
Accesorio multi-enchufe
Accessoire multiprise

Schermo divisorio fonoassorbente in tessuto

Sound-absorbing fabric divider screen / Pantalla divisoria de tela de absorción de sonido / Cloison de séparation de tissu insonorisant



CANAPA
532
F02B

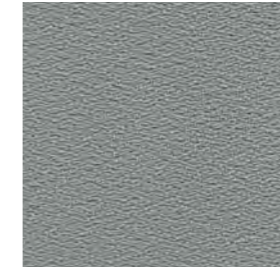

GRIGIO
629
F01A

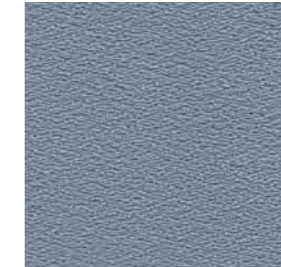

AZZURRO
377
F06F



ANTRACITE
607
F07G

Cuscini per mobili portanti

Cushions for supporting elements / Cojines para muebles portantes / Coussins pour meubles porteurs

Cuscini P 57 in tessuto Jenny. Sfoderabili

Cushions D 57 in Jenny fabric. Removable covers / Cojines P 57 en tejido Jenny. Desenfundables / Coussins P 57 en tissu Jenny. Déhoussables



ZINC
0402



PAPYRUS
0403

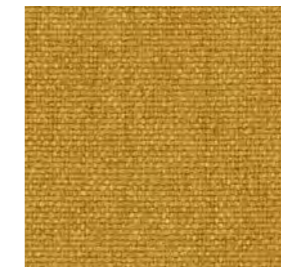

CARIOCA
0503

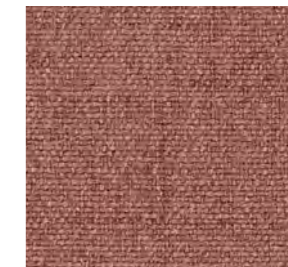

NOX
0903



STEEL
0706



SMOKE
0704



GREY
0601



GREYSTONE
0604



A series of 20 horizontal lines spaced evenly down the page, providing a template for writing.



Ricerca e coordinamento
Colombini S.p.A.

Impaginazione
Bieffe Verona
Fotografia
Biefferending Verona
Fotolito
Bieffe Verona

La Colombini S.p.A. si riserva
di apportare, senza alcun preavviso,
le modifiche che riterrà più opportune
al fine di migliorare il prodotto.

OFFIC'E'
COLOMBINI S.p.A.

Azienda certificata UNI EN ISO 9001
Azienda certificata UNI EN ISO 14001
Strada Ca' Valentino, 124
47891 - Falciano - Repubblica di San Marino

Telefono da Italia 0549 943 573
International calls +378 0549 975 948

www.officocolombinigroup.com